

# **USER MANUAL**

Read the manual carefully and ensure you have fully understood its contents before operating this device for the first time.



## Safety Precautions

### Declaration

Any content and service accessed through this device shall be the property of the applicable third party and subject to protection by regulations and laws on copyright, patent, trademark and other intellectual property rights. No part of such content and service may be modified, duplicated, published, uploaded, distributed, translated, marketed, or used to make and distribute products derived from it without the prior permission of the content owner or service provider.

The manufacturer hereby declares explicitly that the manufacturer shall not be held liable for any guarantee and conditions implied related to this device and any content and service, including but not limited to warranty on marketability, satisfactory quality, fitness for a particular purpose, accuracy, quiet use and nonviolation of any third party 's rights. To the maximum extent permitted by applicable law, the manufacturer gives no guarantee on the accuracy, validity, timeliness, legitimacy and completeness of any content or service provided through this device, or the fitness of such device, content or service for your particular requirement, or the protection from interruption and error during operation of such device, content or service.

To the maximum extent permitted by applicable law, in any case, including fault or neglect, the manufacturer shall not be held liable for legal actions or indemnity obligation arising from any consequence as a result of or related to any information loaded in this device or use of such device, content or service by you or any third party .

Any content or service provided as it is together with this device shall be the property of the applicable third party, therefore Manufacturer gives no declaration or warranty on modification, suspension, cancellation, termination or abortion thereof, and shall not be held liable for legal actions or indemnity obligation arising thereof.

Manufacturer reserves the rights to restrict the use or access of certain content or service. As the contents and services are transmitted through third party's network and transmission facilities, Manufacturer undertakes no customer service thereof or the obligation for such customer service.

### Statement

- The pictures and instructions in this user manual are for reference only, and may be different from the actual product. Please subject to the actual product. (This statement is valid throughout the entire usermanual.)
- Quality upgrades, product design and specifications are subject to change without notice.
- The software content service applicable to this product depends on the third party provider, and some software may not be used due to network, region, service cycle and other problems, which has nothing to do with the product quality. Please contact the third party provider for relevant details.



This symbol alerts user about the presence of a dangerous voltage not isolated inside the product which can be sufficiently powerful to constitute a risk of electrocution.



This symbol alerts user about the presence of important operating instructions and maintenance in the document enclosed in the package.



**ATTENTION**  
RISK OF SHOCK  
ELECTRIC



**Do not open the back cover.**  
In no case the user is allowed to operate inside the device. Only a qualified technician is entitled to operate.



AC voltage: This symbol indicates that the rated voltage marked with the symbol is AC voltage.



DC voltage: This symbol indicates that the rated voltage marked with the symbol is DC voltage.



Class I product: This symbol indicates that it requires a safety connection of protective earthing.

## Disposal of Used Electrical & Electronic Equipment

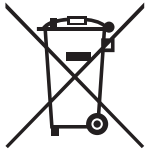

Packaging and electrical goods should be recycled appropriately, and not treated as household waste. Please dispose of this equipment at your applicable collection point for the recycling of electrical & electronic equipment waste. By ensuring the correct disposal of this product, you will help prevent potentially hazardous to the environment and to human health, which could otherwise be caused by unsuitable waste handling of this product. The recycling of materials will help conserve natural resources. Please do not therefore dispose of your old electrical and electronic equipment with your household waste. For more detailed information about recycling of this product, please contact your local city office, your household waste disposal service or the shop where you purchased the product.

## Important Notice

Paragraphs beginning with the symbol  indicate important instructions, tips or conditions for the following settings.



For your own safety and the optimal performance of your screen, ensure to read the safety instructions before performing any installation.

Compatibility with 3rd party products, software and services are not guaranteed. We cannot be held liable for any damage or loss suffered whilst operating, using or connecting to incompatible devices or apps.

The recording and playback of content on this or any other device may require permission from the owner of the copyright or other such rights in that content. It is your responsibility to ensure that your use of this or any other device complies with applicable copyright legislation in your country. Please refer to that legislation for more information on the relevant laws and regulations involved or contact the owner of the rights of the content you wish to record or playback.

**Read these instructions**  
**Follow all instructions**  
**Heed all warnings**  
**Keep these instructions**  
**All rights reserved.**



EU importer: Gorenje gospodinjnski aparati, d.o.o.  
ADD: Partizanska cesta 12, 3320 Velenje Slovenija  
UK importer: Alltrade Ltd.  
ADD: Sussex House Business Park, 274 Old Shoreham Road, BRIGHTON & HOVE, BN3 7EU

## Safeguards

Please read the following safeguards for your device and retain for future reference. Always follow all warnings and instructions marked on the device.

### 1. A note about safety and operating instructions

Read and follow all safety and operating instructions, and retain them safely for future reference.

### 2. Heed Warnings

Adhere to all warnings on the appliance and in the operating instructions.

### 3. Cleaning

Unplug the device from the wall outlet before cleaning. Do not use liquid, abrasive, or aerosol cleaners. Cleaners can permanently damage the cabinet and screen. Use a lightly dampened cloth for cleaning.

### 4. Water and Moisture

Avoid dripping or splashing of liquids onto the product. Objects filled with liquids, such as vases, should not be placed on the product.

### 5. Ventilation

Slots and openings in the cabinet are provided for ventilation, to ensure reliable operation of the device and to protect it from overheating. Do not cover the ventilation openings in the cabinet and never place the set in a confined space such as built-in cabinet unless proper ventilation is provided. Leave a minimum 10cm gap all around the unit.

### 6. Power Source

This device should be operated only from the type of power source indicated on the marking label. If you are not sure of the type of power supplied to your home, consult your appliance dealer or local power company. If use the power source Less than or equal to AC 120V, the air switch is necessary. And the air switch current specifications are greater than 20A. The installation location is easy to operate and the electric control box must be locked. Power and grounding requirements compliance professionals or consult your appliance dealer.

### 7. Power-Cord Protection

Power- supply cords should be routed so that they are not likely to be walked on or pinched by items placed upon or against them, paying particular attention to cords at plug, wall outlets, and the point where they exit from the device. Main plug is used as the disconnect device, the disconnect device shall remain readily operable.

### 8. Lightning

For added protection for this device during a lightning storm, or when it is left unattended and unused for long periods of time, unplug it from the wall outlet and disconnect the cable system. This will prevent damage to the device due to lightning or power-line surge.

### 9. Overloading

Do not overload wall outlets and extension cords as this can result in a risk of fire or electric shock.

### 10. Object and Liquid Entry

Never push objects of any kind into this device through openings as they may touch dangerous voltage points or short-out parts that could result in fire or electric shock. Never spill liquid of any kind on or into the device.

### 11. Servicing

Do not attempt to service this device yourself as opening or removing covers may expose you to dangerous voltage or other hazards. Refer all servicing to qualified service personnel.

### 12. Damage Requiring Service

Unplug the device from the wall outlet and refer servicing to qualified service personnel under the following conditions:

- (a) When the power - supply cord or plug is damaged.
- (b) If liquid has been spilled, or objects have fallen into the device.
- (c) If the device has been exposed to rain or water.



(d) If the device does not operate normally by following the operating instructions. Adjust only that are covered by the operating instructions as an improper adjustment of other controls may result in damage and will often require extensive work by a qualified technician to restore the device to its normal operation.

(e) If the device has been dropped or the cabinet has been damaged.

(f) When the device exhibits a distinct change in performance - this indicates a need for service.

### 13. Replacement Parts

When replacement parts are required, be sure the service technician has used replacement parts specified by the manufacturer or have the same characteristics as the original part. Unauthorized substitutions may result in fire, electric shock or other hazards.

### 14. Safety Check

Upon completion of any service or repair to the device, ask the service technician to perform safety checks to determine that the device is in safe operating condition.

### 15. Heat

The product should be situated away from heat sources such as radiators, heat registers, stoves, or other products (including amplifiers) that produce heat.

### 16. Fire

The product should be situated away from naked flame sources such as lighted candle.

### 17. Off-gassing

The device smells of plastic is normal and will dissipate over time.

### 18. Installation

(a) Professionals carry out installation and removal, and execute safety inspection after installation.

(b) The installed power cord should be hidden or protected to avoid tripping, crushing cause damage.

(c) The LED display can be connected to a maximum of five by five cabinets.

### 19. Use environment requirements:

(a) indoor.

(b) The operation ambient temperature should be kept between 0°C and 40°C.

(c) The operation ambient humidity should be kept between 10% and 90%RH (no frost).

(d) waterproof.

(e) The operation altitude is less than 5 km.

### 20. Daily use

(a) Check the screen whether missing or not before powering on.

(b) Turn off the power when the LED display is not in use.



Incorrect replacement of the battery may lead to the risk, including the replacement of another similar or the same type. Do not expose batteries to heat such as sun or fire or something like that.



The device should not be exposed to dripping and spraying and it cannot be placed under objects filled with liquids.



Main plug is used as the disconnect device, the disconnect device shall remain ready for operating.



Apparatus with CLASS I construction shall be connected to a MAINS socket outlet with a protective earthing connection.



# CONTENTS

Accessories List.....	1
Remote Control .....	2
Front Panel & Interface.....	4
Making Connections.....	5
Initial Start.....	8
Use of Menu .....	12
Serial Protocol .....	19
Other Information.....	20
Trouble Shooting .....	21
Other Information.....	23
Installation Guideline .....	25



## Accessories List

Remote Control × 1

Battery × 2

User Manual × 1

Power cord × 2

### NOTE

- The accessories may be different from the list above due to different models, countries / regions, please refer to the actual accessory bag.

# 2

## Remote Control

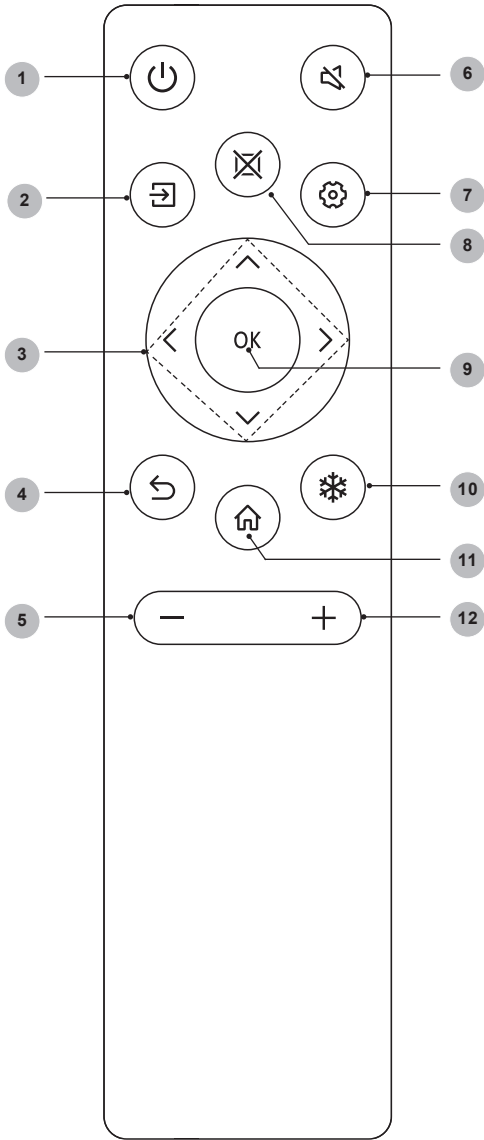

Number	Description
1	Power Enter/exit standby
2	Source Switching signal source
3	^ / v Move focus up/down < / > Move focus left/right
4	Back Back to previous menu
5	Volume down (-)
6	Mute Activate/exit mute state
7	Setting Open the Settings menu
8	Blank Switch On/Off screen
9	OK Confirm operation
10	Freeze once click: Keep the current screen Twice click: Disable/Enables touch function for IDB screen
11	Home Enter home page
12	Volume up (+)

## Battery replacement method

1. Disconnect the battery cover from the remote control at the battery cover buckle and open the battery cover.
2. Insert two AAA 1.5V alkaline batteries. Note that the positive (+) and negative (-) terminals of the batteries must match the positive (+) and negative (-) terminals in the battery case.
3. Close the battery cover from top to bottom until it is fully aligned with the remote control.

## Precautions

1. If the remote control is not working properly, is unstable, or can't control the device, please replace the batteries.
2. If you do not use the remote control for a long time or the battery is exhausted, remove the battery. (Waste batteries pollute the environment and must be handled properly.)
3. In order to achieve the best remote control effect, please point the black launch window on the back of the remote control at the indicator light of the device.
4. Discard batteries in a designated disposal area. Do not throw them into a fire.
5. Remove old batteries immediately to prevent them from leaking into the battery compartment.
6. Battery chemicals can cause a rash. If the batteries leak, clean the battery compartment with a cloth. If chemicals touch your skin then wash it immediately.
7. Do not mix old and new batteries.
8. Do not mix alkaline, standard (carbon-zinc) or rechargeable (NiCd, NiMH, etc.) batteries.
9. Do not continue using the remote if it gets warm or hot.
10. If any of these issues occur, call our Support Center immediately on the support website.

## Effective range

1. Remote control distance: The distance from the front of the remote control is valid within 8m.
2. Remote control angle: With the remote control receiving window of the device as the apex, the angle in horizontal direction at the distance of 6m is at least  $\pm 30^\circ$ , and the angle in vertical direction is at least  $\pm 15^\circ$ .

# 3

## Front Panel & Interface

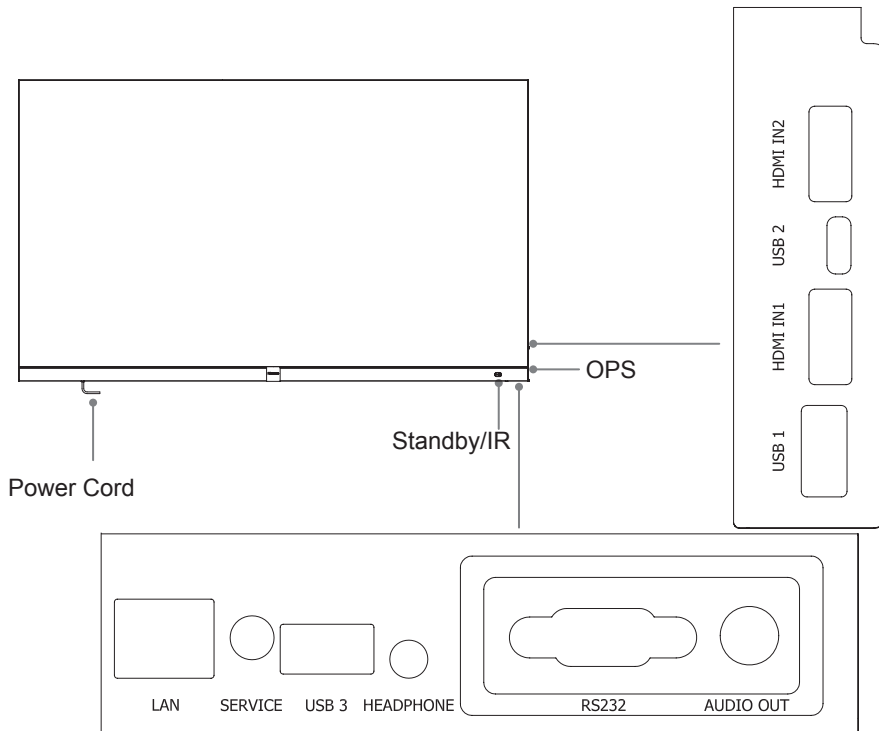

Item	Description
Standby button	<p>When the device is on, short press the button to turn off the screen, long press the button to go into standby mode.</p> <p>When the screen is off, press the button to open the screen, and when the device is on standby, press the button to start.</p> <p>The indicator light displays the state of power on or standby:</p> <ul style="list-style-type: none"> <li>• When the device is on, the light is blue.</li> <li>• When standby, the light is red.</li> <li>• When the device with OPS module is turned on, the light is green.</li> </ul>
USB	Connect USB devices such as hard disks, keyboard, mouse, etc. [5V DC/0.5A]
HDMI IN	The front HDMI interface allows digital audio and video signals to be transmitted using a single cable without compression. HDMI supports multi-channel digital audio, and can be connected to external devices with HDMI port.
HEADPHONE	Audio out to Headphones
RS232	Serial interface, used for mutual transfer of data between devices
AUDIO OUT	Connect to power amplifier via coaxial port, then connect power amplifier to speaker
SERVICE	For factory commissioning, don't insert any cables
LAN	Standard RJ45 Internet connection interface
OPS PORT	Port for adding OPS module

# 4 Making Connections

## ▶ Connect to USB interface device

The total current of all the USB output ports of the device when connected to external devices at the same time mustn't exceed 1000mA, or else the device failure caused by overcurrent isn't covered by the warranty.

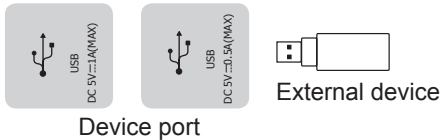

### NOTE

This device is connected to wireless keyboard and mouse devices. If there is any insensitivity phenomenon during use, you can try to change the wireless receiver to another USB port, or use a USB extension cord to connect the wireless receiver in order to enhance the receiving range.

## ▶ Connect to HDMI input

Connect the HDMI input connector of the device to the HDMI output port of an external device.

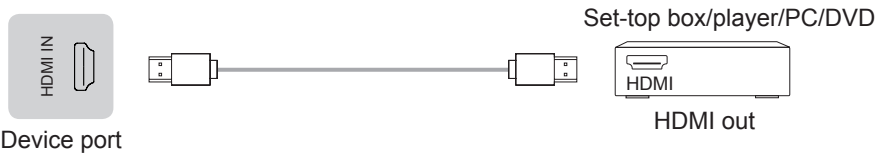

### NOTE

The supported signal formats of the HDMI port refer to Specifications.

## ▶ Connect to external audio device

Audio output: connect to power amplifier via coaxial port, then connect power amplifier to speaker.

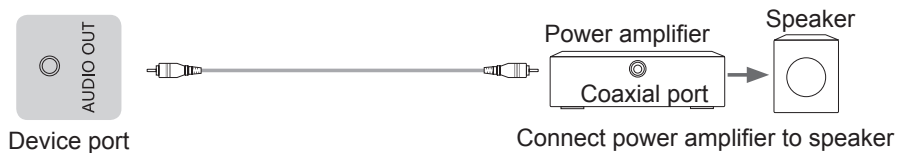

## ► Connect to network

Enter the **Settings** menu and select the **Network** item.

### ● **WIFI**

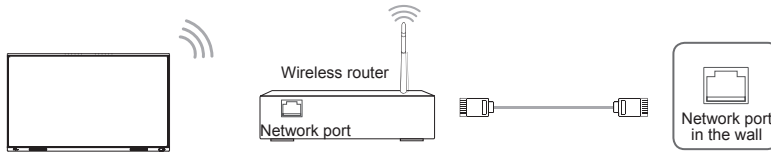

The device can receive network signals directly through Wireless router

- The available wireless network list is automatically displayed when the WIFI is selected.
- Select an available network, enter the password, and tap Connect. If the selected network is not encrypted, you can connect directly.
- If the network you want to connect to is not displayed in the list, tap Refresh to display more networks. If the network you want is still not displayed after this operation, tap Add Network and enter the network name manually, select the corresponding encryption method according to router settings, enter the password, and tap Confirm.

### ● **Ethernet**

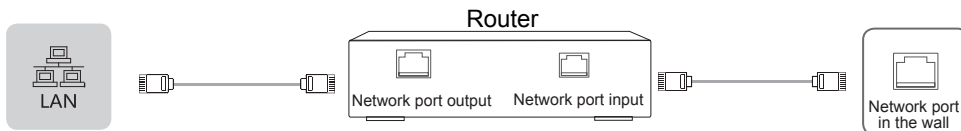

Device port

#### • **Ethernet: auto**

The device automatically obtains an IP address and connects to the network. If failure, repeat the operation again or choose Ethernet:manual.

#### • **Ethernet: manual**

Manually enter the IP Address, Subnet Mask, DNS Server and Gateway.

## ► Connect to the OPS interface device

OPS (Open Pluggable Specification) is the interface specification developed by INTEL which is applicable to embedded computer module products. With this interface, the screen can be connected to the device in compliance with OPS interface specification, which is short for OPS module. You can buy the module and conduct secondary development in accordance with your requirements. Recommended adaptable OPS modules is S02BDS5A811E;

This product can provide the OPS module with 19V±0.5V (3.4A MAX) power supply.

### 📌 **NOTE**

It is recommended to choose and purchase OPS computers with the i3/i5/i7 latest generation processor, 4G memory, 128 GB solid state drive or above.

You should purchase the OPS module which is applicable to the size of the device OPS. The size of OPS refers to the following figure:

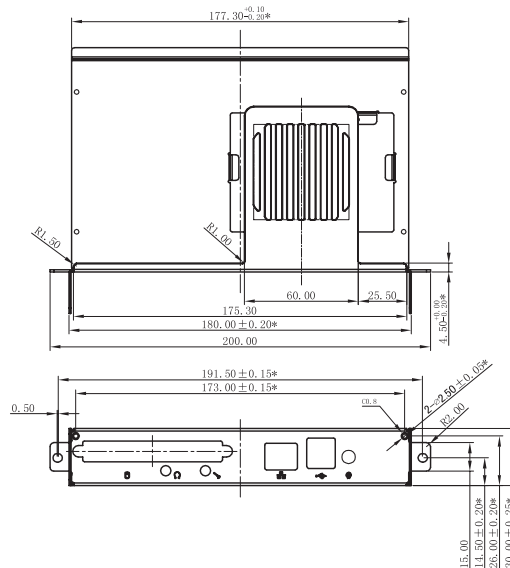

### • Switching on/off the OPS

After inserting OPS to the device, you turn on the device, change the signal source to enter OPS and stays on the OPS system interface. When you turn off the device, you should use the standby button to go into standby mode, the OPS module is switched off, and then you shut off the device.

#### [ Description ]

- Powering off the unit directly may damage the hard disk of the OPS module. It is strongly recommended that you use the following two methods to shut down:
  - 1 When switching off the unit, please use the remote control to make the unit be in a standby mode. At this time, the OPS module will be shut down normally, followed by the power cutoff.
  - 2 Switch off OPS manually. Switch off the computer switch in the setup menu, or use the start menu in the computer.
- When OPS is illegally shut down due to the direct power cutoff of this unit, the WINDOWS fix interface will appear. At this time, the USB keyboard or wireless key board should be used to confirm the fix. After the fix is complete, the system will continue to enter the system.

### OPS Setup

For a brand new OPS module, there is need to enter the BIOS and set the module. Follow the prompts to enter the BIOS option during the OPS boot process, and do the followings in Advance:

- 1 Set USB Keyboard/Mouse Wakeup is set as Enabled;
- 2 Restore AC Power Loss is set as Power Off
- 3 Enter the power options in the WINDOWS control panel, set the display off time and sleep time to “Never” respectively, and define the function of the power button as “Shutdown”.

#### [ Description ]

- If the OPS module enters the off state and there is no any operation taken on the computer for a long time, the unit will enter the standby state. If there is need to use the OPS, restart the computer.



# 5 Initial Start

## Switching on/off

- Connect the power cord of the device to a 100V to 240V AC outlet.
- Press the standby button [⏻] on the remote control in the power on state to switch the device to standby; to resume normal watch, simply press the standby button [⏻] on the remote control again.
- To turn off the device, press the power switch or Unplug the Power cord.

## NOTES

- When the AC power is turned off, wait at least 1 minute before turning it on again in order to prevent problems of the device.

## Turning the device on for the First Time

1. The first time you turn the device on, it will go straight into the Installation Guide.
2. Press the [ ^ / v / < / > ] buttons to navigate the menu and change the settings. Press the [OK] button to confirm.

<b>Language</b>	Please set the system language
<b>User statement</b>	Accept the agreement
<b>Network settings</b>	For better value-added services, please use the Internet for your first connection
<b>Time Zone</b>	Please select time zone

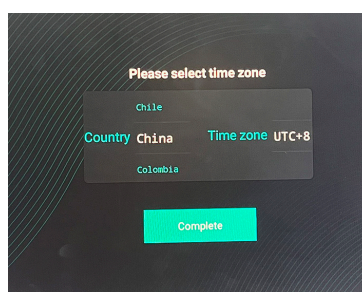
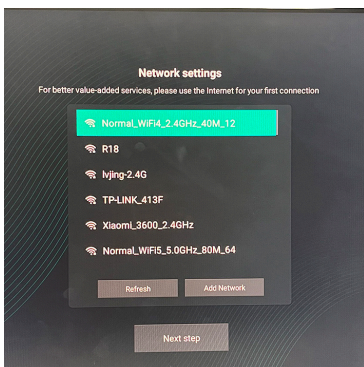
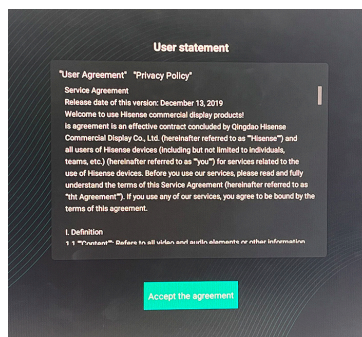
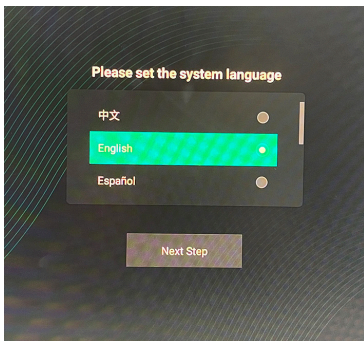

## App

- Choose the App icon to select Application and File.

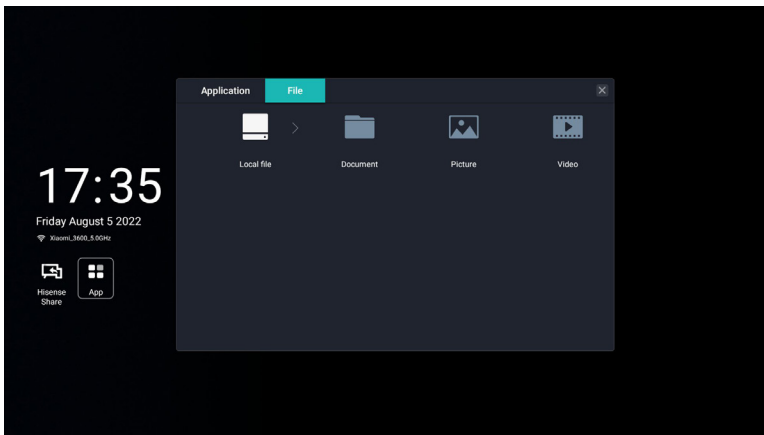
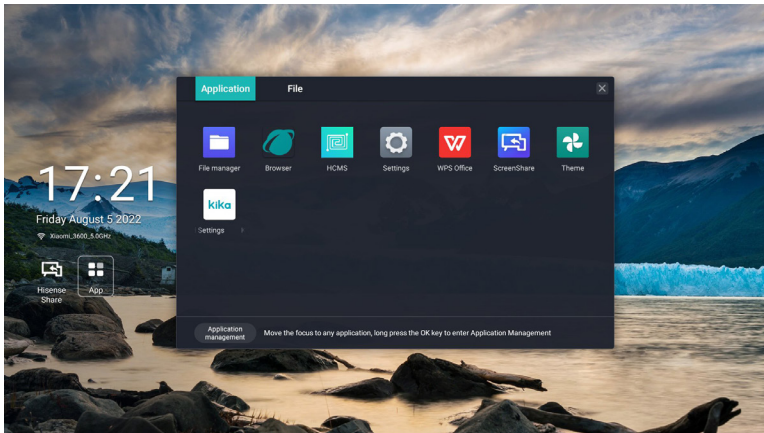

- **Hisense Screen Share**



- **Guide for Dongle**

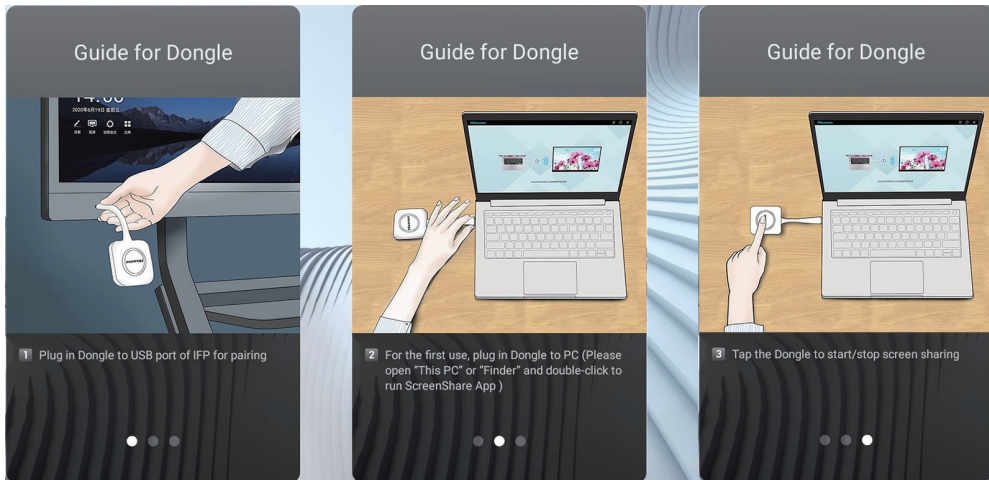

(1) Pairing

Pairing method:

Insert the Miracast into the USB port of the whole machine, and pair it. After successful, insert it into the USB port of computer, and automatically run Miracast software. Click Miracast button according to the prompts.

Pairing and Miracast can be performed under both Android and Windows, and there is no need to re-pair when switching to another system after pairing.

(2) Startup/termination of Miracast

Tap Miracast to start/terminate the Miracast.

- **Guide for PC**

Setting name, pairing password, LAN Miracast, whether to activate the connection code, screen group.

- Guide for Phone

1. Download method:

Official website of Hisense Commercial Display or scan QR code at the large-screen terminal.

This app can also be found by searching for “HisenseScreenShare” in the Google App Store and Apple App Store



## Hisense Screen Share

Hisense Commercial Display

2. Main functions of the mobile terminal

File transfer, remote control, screen mirroring, etc.:

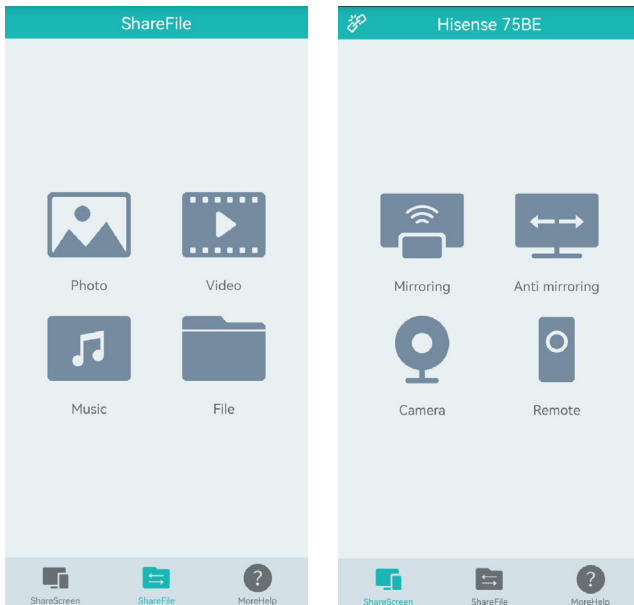

# 6

## Use of Menu

### Universal

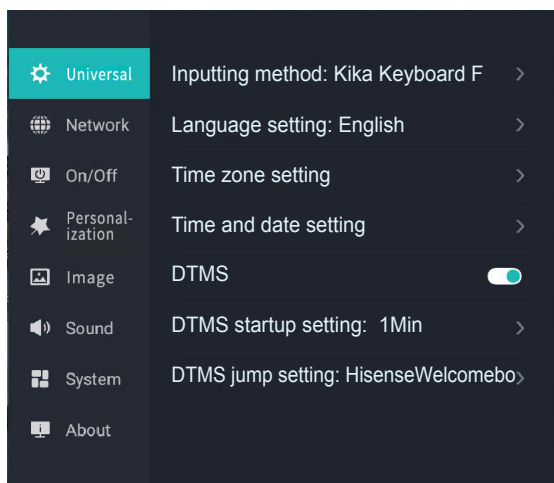

- Inputting method: switch the input method. The default input method is Kika.
- Language setting: Select menu language as Chinese/English/French/German/Spanish/Italian/ Polish/ Arabic.
- Time zone setting: Set the current time zone, the default is China UTC+8, and it is sorted by the first letter of the English name of the region.
- Time and date setting: Set the date and time, you can select Network sync on / Network sync off /Date / Time.
- DTMS : You can select on, off and off-by-default. When the switch is switched on, the jump time and jump page are supported. When the switch is switched off, the jump time and jump page are set to gray, and standby for 10 minutes. (Under the physical channel, the default is to enter standby if there is no signal for 10 minutes)
- DTMS startup setting: The time is calculated in minutes, and supports 1, 5, 10, 15, 30, 45 and 59.
- DTMS jump setting: The home page is selected by default and applications installed by users are supported. After the setting time, there is no signal jump. The applications installed by users are displayed as a list at the bottom of the home page.

## Network

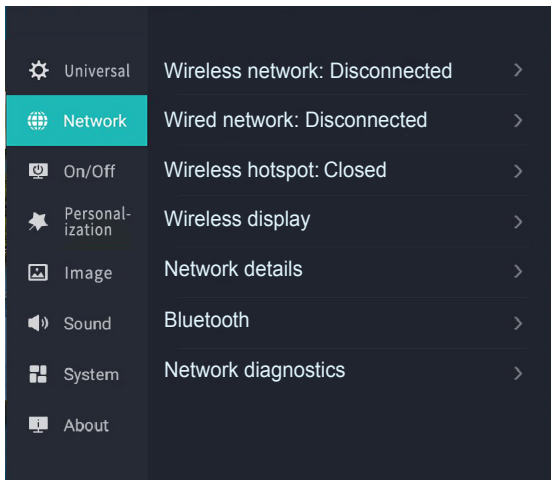

- **Wireless network:** Switch on the wireless network, display the connection status of the wireless network and the list of available networks. You can choose to refresh or manually add networks that do not appear in the list.
- **Wired network:** Display the connection status of the wired network. (When the wireless network is not connected, the device will automatically connect to the wired network after connecting to the network cable.) You can set to obtain IP automatically and input IP manually.
- **Wireless hotspot:** When switched on, the device turns into a router to share the wireless network. You can choose on, off and on-by-default.
- **Wireless display:** The mobile device can be connected to display contents on the mobile device. Wireless network card/Miracast support is required.
- **Network details:** You can view network details, such as connection status, IP address, Netmask, Gateway, DNS, wired MAC, and wireless MAC, etc.
- **Bluetooth:** Nearby Bluetooth devices can be connected. You can select a Bluetooth switch, Paired device, Available device, and Search device.
- **Network diagnostics:** Test and diagnose the connection status of the current network.

## On/Off

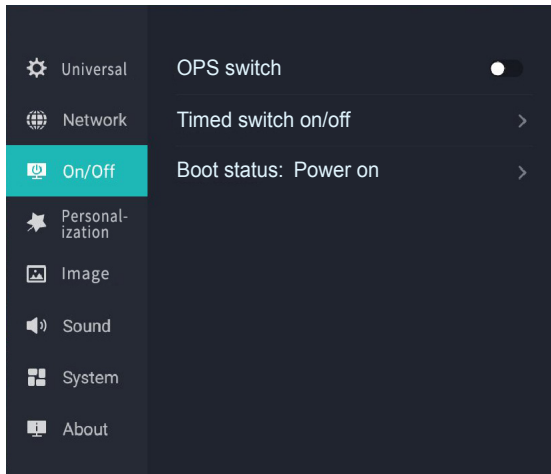

- OPS switch: Switch on or off, and off-by-default.
- Timed switch on/off: Set the fixed on/off time, and it will be commenced automatically when the time is up. The clock can set hours and minutes in a 24-hour mode, and three on/off time periods can be set every day. Display three time periods, each of time period switch is set as off-by-default, and the default value is 00:00-00:00.
- Boot status: The boot status can be set to power on, standby or memory. On-by-default.

## Personalization

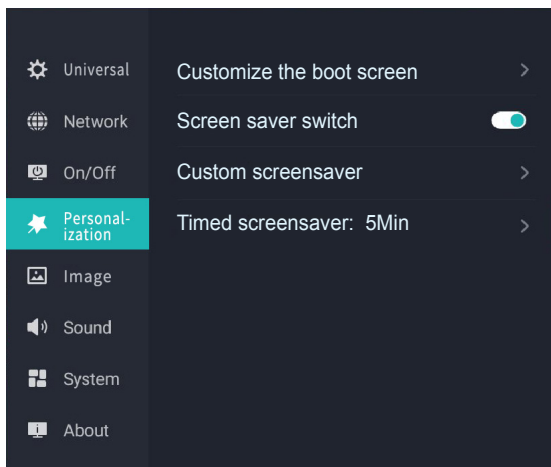

- Customize the boot screen: Select a power-on picture. Presets, pictures in local USB storage can be selected as the boot screen.
- Screen saver switch : Switch on or off the Screen saver switch.
- Custom screensaver: You can choose the default screen-saver, or customize the screen-saver. When customizing the screen-saver settings, you can select from the U disk or scan the code to upload the screen-saver picture.
- Timed screensaver: Set the time for the screen saver to appear. 5 minutes, 15 minutes, 30 minutes, 45 minutes, 60 minutes can be selected, the default is 5 minutes.



## Image

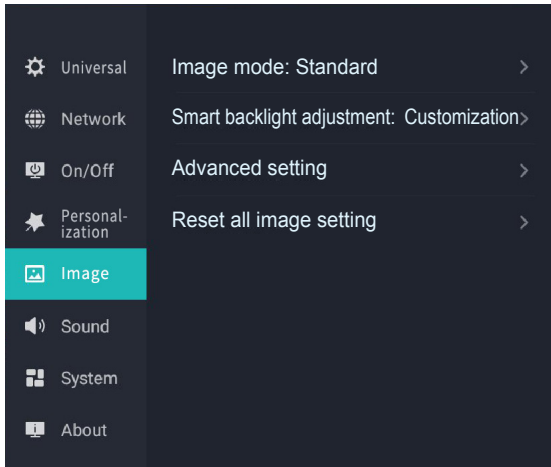

- Image mode: Select the appropriate picture effect according to the content you are watching. You can select Standard, Meeting, Cinema, Showroom, HDR Standard, HDR showroom, and Default Standard. (When playing HDR source, you can select HDR Standard and HDR showroom)
- Smart backlight adjustment: Featured display technology to realize independent control of screen brightness by backlight module. You can select Intelligent Light Sensor, Bright light, Soft light and Customization mode. The default is Customization mode.

### **NOTE**

If the Intelligent Light Sensor is turned on, the device automatically recognizes the ambient light after power on and readjusts the brightness. Then the screen flashes and the user interface appears, which is a normal phenomenon.

- Advanced setting: Provide picture noise reduction, gamma and other parameter options to achieve fine adjustments of professional picture quality.
- 1) Contrast: 0-100, the default is subject to the picture quality specification.
- 2) Brightness: 0-100, the default is subject to the quality picture specification.
- 3) Chroma: 0-100, the default is subject to the quality picture specification.
- 4) Sharpness: 0-20, the default is subject to the quality picture specification.
- 5) MEMC: You can select off, Clear, Standard, Smooth, and off-by-default.
- 6) Dynamic contrast: You can select off, on and on-by-default.
- 7) Luminance dynamic range: Auto, All, Limit can be selected, and the default is Auto.
- 8) Image denoise: Select Off, Low, Middle, High, and the default is Middle.
- 9) Gamma: Select Standard, Brighter, Darker, and the default Standard.
- 10) Color temperature: Selectable 2000K, 3000K, 4000K, 5000K, 6000K, 6500K, 7000K, 7500K, 8000K, 9000K, 9300K, The default value is 9300K.
- 11) White balance: Red gain, green gain, blue gain, red Offset, green Offset, blue Offset can be selected, the adjustment range (-30-----+30), the default is 0.
- 12) Color correction: Red, green, blue, cyan, yellow, purple, skin color can be selected. Adjustment range (-15 ----- + 15), default as 0.
- Reset all image setting: Reset all changes in image settings to default values.



## Sound

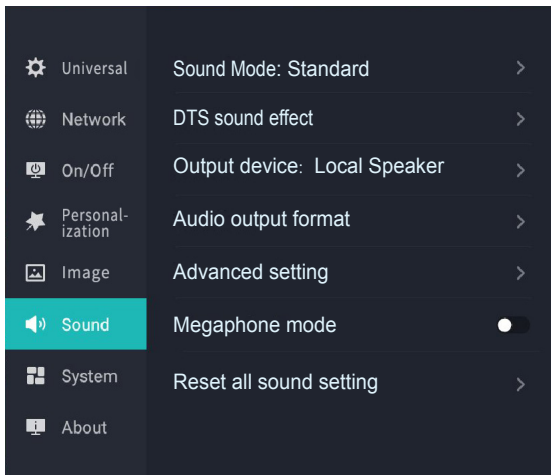

- Sound Mode: Select the appropriate sound effect according to the content you are watching. You can select Standard, Sports, Movie, Music, Customization, and Default Standard.
- DTS sound effect: Switch on or off DTS Bass Boost, DTS Virtual Sky Tone, DTS Clear Dialogue, DTS Loudness Adjustment, or select Reset.
- Output device: Select the device or external speakers as the sound output device. You can choose the local speaker, HDMI ARC, coaxial, USB audio device, the default local speaker.
- Audio output format: Select the audio output format of the external device. (Only when coaxial or HDMI is selected as the output device). When the output device is coaxial, the audio output format supports PCM and Auto. When the output device is HDMI ARC, the audio output format supports PCM, Auto and transparent transmission, and the default is Auto.
- Advanced setting: Further adjust parameters such as equalizer, balance, audio and video synchronization, and realize refined adjustment of sound effects.
  - 1)Balance: Selectable (-10--10), default is 0.
  - 2)Equalization: 100Hz, 250Hz, 600Hz, 1KHz, 2.5KHz, 6KHz, 10KHz can be selected, the adjustment range is -10--+10, and the default is 0.
  - 3)Automatic volume control: You can choose On or Off (SOC support is required), the default is Off.
  - 4)Audio and video synchronization: Selectable (-10 to 10), the default is 0.
- Megaphone mode: You can choose ON or OFF , the default is OFF.
- Reset all sound setting: Reset all changes in the sound settings to default values.

## System

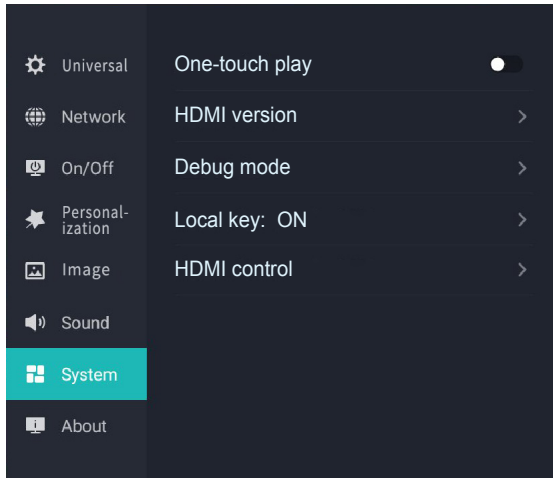

- One-touch play: After switched, connect the set-top box, computer and other external devices, and the device will automatically play the device screen. You can select On or Off.
- HDMI version: HDMI1.4, HDMI2.0.
- Debug mode: Call native Android settings.
- Local key: When it is switched on, it will not be shielded, and when it is switched off, the local key will be shielded. It is switched on by default.
- HDMI control  
CEC control: You can choose ON or OFF , the default is OFF.  
Device Auto Power Off: You can choose ON or OFF , the default is OFF.  
Automatic switch: You can choose ON or OFF , the default is OFF.

## About

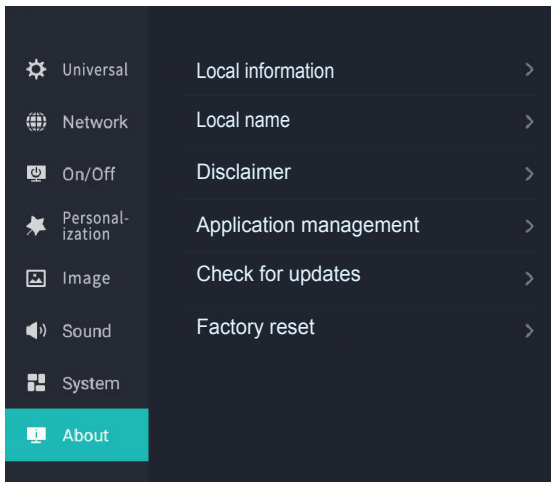

- Local information: Display local information. Software Version, Device ID, Machine Number, and System Capacity can be selected.
- Local name: Select or customize the local name to facilitate the discovery of devices during Bluetooth pairing, screen projection and other operations. The default name of this unit is HAIO-XX, and XX is the last two digits of the MAC address.
- Disclaimer: Display the local service agreement and disclaimer.
- Application management: Manage local application software, check the used space and remaining space. You can select Application Name, Version, Size, Used Space, Remaining Space.
- Check for updates: Manually check and upgrade software.
- Factory reset : Reset all changes in the system settings to the default values.

# 7

## Serial Protocol

### Serial port status

The device can receive the serial port command sent by the external controller or OPS of the device. Refer to the following table for the specific command protocol:

1. Baud rate: 115200 2. Control section: PC → The device 3. Response section: TV → PC

			Protocol header		Length		Command code				DATA	Verify	Protocol tail		Remark	
Source	Computer	PC to TV	DD	FF	00	06	A1	06	00	00	02	XX	BB	CC	XX is the check digit	
		TV to PC	AB	AB	00	06	A1	06	00	00	01	XX	CD	CD		
	HDMI1	PC to TV	DD	FF	00	06	A1	06	00	00	00	XX	BB	CC		
		TV to PC	AB	AB	00	06	A1	06	00	00	01	XX	CD	CD		
	HDMI2	PC to TV	DD	FF	00	06	A1	06	00	00	01	XX	BB	CC		
		TV to PC	AB	AB	00	06	A1	06	00	00	01	XX	CD	CD		
Volume Control	PC to TV		DD	FF	00	06	A1	09	00	00	VV	XX	BB	CC	XX is the check digit	
	TV to PC		AB	AB	00	06	A1	09	00	00	01	XX	CD	CD		
Switch on/off	Screen on	PC to TV	DD	FF	00	07	C1	31	00	00	00 01	XX	BB	CC		XX is the check digit
		TV to PC	AB	AB	00	07	C1	31	00	00	01 00	XX	CD	CD		
	Screen off	PC to TV	DD	FF	00	07	C1	31	00	00	01 01	XX	BB	CC		
		TV to PC	AB	AB	00	07	C1	31	00	00	01 01	XX	CD	CD		
Set Time (H/M/S)	YY MM DD	PC to TV	DD	FF	00	08	C1	1C	00	00	YY MM DD	XX	BB	CC	XX is the check digit	
		TV to PC	AB	AB	00	09	C1	1C	00	00	01 YY MM DD	XX	CD	CD		
	HH MM SS	PC to TV	DD	FF	00	08	C1	1D	00	00	HH MM SS	XX	BB	CC		
		TV to PC	AB	AB	00	09	C1	1D	00	00	01 YY MM DD	XX	CD	CD		
Reboot Screen	PC to TV		DD	FF	00	06	C1	1E	00	00	01	XX	BB	CC	XX is the check digit	
	TV to PC		AB	AB	00	06	C1	1E	00	00	01	XX	CD	CD		
Software Version Query	PC to TV		DD	FF	00	06	C1	1B	00	00	01	XX	BB	CC	XX is the check digit	
	TV to PC		AB	AB	00	09	C1	1B	00	00	01 YY MM DD	XX	CD	CD		

- Verify is the exclusive OR of Length, Command code, ID and Data.
- All data are hexadecimal values.
- For all commands received by the device, the protocol header needs to be changed to AB AB and the protocol tail needs to be changed to CD CD when returning to the PC.

# 8

## Other Information

### Recycling/Licenses

#### WEEE (Waste Electronic Electric Equipment)

##### European Directive 2012/19/EU



This symbol on the product or on its packaging indicates that this product must not be disposed of with your household waste. Instead, it is your responsibility to dispose of your waste equipment by handing it over to a designated collection point for the recycling of waste electrical and electronic equipment.

The separate collection and recycling of your waste equipment at the time of disposal will help to conserve natural resources and ensure that it is recycled in a manner that protects human health and the environment. For more information about where you can drop off your waste equipment for recycling, please contact your local city office, your household waste disposal service or the shop where you purchased the product.

### Batteries



In accordance with the Battery Directive, used batteries should not be disposed of in the domestic waste. Dispose your batteries in the collection containers specific for this purpose in retail stores.

### ROHS (Restriction of Hazardous Substance)

#### European Directive 2011/65/EU



This European directive limits the use of dangerous and hazardous substances which are difficult to recycle.

This allows recycling easily the EEE and contributes to the safeguard of the environment.

Substances included in this product match to the RoHS directive.

### Certification and Compliance

#### FCC Notice

pursuant to Part 15 of the FCC Rules. These limits are designed to provide reasonable protection against harmful interference in a residential installation. This device generates, uses, and can radiate radio frequency energy and, if not installed and used in accordance with the instructions, may cause harmful interference to radio communications. However, there is no guarantee that interference will not occur in a particular installation. If this device does cause harmful interference to radio or television reception, which can be determined by turning the device off and on, the user is encouraged to try to correct the interference by one or more of the following measures:

- Reorient or relocate the receiving antenna.
- Increase the separation between the device and receiver.
- Connect the device into an outlet on a circuit different from that to which the receiver is connected.

This device has been tested and found to comply with the limits for a Class B digital device

- Consult the dealer or an experienced radio/Screen technician for help.

NOTE: The manufacturer is not responsible for any radio or Screen interference caused by unauthorized modifications to this equipment. Such modifications could void the user's authority to operate the equipment. The Wi-Fi Module complies with FCC radiation exposure limits set forth for an uncontrolled environment. This device should be installed and operated with a minimum distance of 20 centimeters between the radiator and your body. This device complies with Industry Canada's licence-exempt RSSs. Operation is subject to the following two conditions:

- (1) This device may not cause interference;
- (2) This device must accept any interference, including interference that may cause undesired operation of the device.

# 9

## Trouble Shooting

Before preparing for repair, check according to the table below to see if you can find the cause of the problem. If you strictly follow the instructions but still can't resolve the problem, you can turn to professional servicemen for help.

Problem	Solution
No sound or picture	<ul style="list-style-type: none"> <li>•Check if the power cord is connected to the wall outlet, and if the wall outlet is energized.</li> <li>•Check if you have pressed the Power button or Standby button.</li> <li>•Check the volume.</li> </ul>
Sound and picture are disturbed	<ul style="list-style-type: none"> <li>•Try to find the appliance that affects the LCD monitor and keep it away.</li> <li>•Try plugging the LCD monitor's power plug into another outlet.</li> </ul>
The screen cannot be powered on or the power indicator light is off.	<ul style="list-style-type: none"> <li>•Check whether the power supply is connected.</li> <li>•Check whether the power supply plug is properly connected.</li> <li>•Check whether the power outlet has electricity.</li> <li>•Check whether the AC switch is enabled.</li> <li>•Press the reset switch and start the system again.</li> </ul>
The unit turns off unexpectedly.	<ul style="list-style-type: none"> <li>•Check whether standby mode is enabled.</li> <li>•Check if there is a power outage in your area.</li> <li>•Turn on the display and see if the problem is with the signal and control system.</li> </ul>
Remote Control is not working.	<ul style="list-style-type: none"> <li>•Check whether something is obstructing the display's remote control receiver.</li> <li>•Check whether the batteries in the remote control are installed correctly.</li> <li>•Check whether the batteries need to be replaced.</li> </ul>
There is no sound when the HDMI in channel is used.	<ul style="list-style-type: none"> <li>•Remove and insert the HDMI cable again.</li> </ul>
The internal PC has no signal.	<ul style="list-style-type: none"> <li>•Check whether the internal PC is properly inserted in the slot.</li> <li>•Check whether the internal PC is in shut down mode.</li> <li>•Press the power button on the internal PC, and manually start up the internal PC.</li> </ul>

### • LED All-IN-ONE Maintenance

The maintenance of LED display system mainly includes the maintenance of LED display system, communication system and power system.

### Precautions for LED display screen

Small pitch LED display screens are high-precision, high-density electronic products, which belongs to precision protection products category. It needs special protections in daily use such as protections from static electricity, dust, moisture and physical impact.

#### 1. Static electricity

LED is an electroluminescence device, which is very sensitive to current. Human body carries static electricity which can break down the internal PN junction. Do not touch the LED display screen without wearing gloves.

#### 2. Dust

The LED display screen is designed according to the indoor IP3X standard, but it contains high-density electronic circuit inside the box. So it is very important that the LED display screen is dust proof and clean it regularly.

#### 3. Water vapor and oil fume

LED beads surface can not be treated with water proofing due to its density and sizing, Moisture environment and water vapor can cause short circuit easily which may resulting product failure or even resulting fire that may burnt the LED display screen in the worst case. Therefore, LED display screen needs protection from water vapor and moisture.

#### **4. Physical impact**

The LED display screen is a very delicate device. It needs protection from any kind of physical impact, as it may resulting damage to LED beads or circuit board.

##### **Maintenance of LED display screen**

1. The control PC, video processor and other equipment shall be placed in a dry and clean environment with good ventilation. Avoid direct sunlight to all the equipment. The ambient temperature should be kept between 18°C and 25°C.
2. Do not place any container which containing fluid on the screen, to prevent water damage to the product.
3. Turn off the power supply of the corresponding equipment before unplug the cables to prevent damage to the interface components.
4. Avoid the interference of electromagnetic field (such as non magnetic speaker, loudspeaker, etc.).
5. In order to prevent the instantaneous current pulse from affecting the computer, it is advised to turn on the power of the LED display screen first and then the power of the computer. Turn off the power of the computer before the power of the LED display screen when it is shutting down.
6. Always back up important data and files.
7. Do not plug and unplug the communication plugs to prevent damages.
8. External protection measures shall be taken when laying communication cables.
9. Advice on air-conditioner on site: On-site conditioning and other equipment outlet can not be blown against the product. The temperature shall set at  $25 \pm 1$  °C.
10. Using Frequency of LED: At least twice a week power-on and more (no less than 2 hours each time. It is suggested that the product can also be kept in standby mode at ordinary times.
11. The LED AIO display shall be well ventilated. The temperature and humidity differences between the inside and outside shall not be greater than 5 degrees;

##### **Maintenance of power system**

1. Daily inspection on power supply system is advised to detect any problems on time.
2. Clean the interior of the distribution cabinet with leather blower or air pressure gun regularly. Fasten any loose screws in the distribution cabinet, it is advised to clean it once a month.
3. Shut off the power supply of the system during thunderstorm season or when it is not being used for a long time.
4. The maintenance of power system shall be carried out only by certified electricians.

#### **Transportation and storage**

##### **1. Transportation**

The LED AIO display is required to be transported after packaging. During transportation, it is strictly prohibited to put the packaging upside down; Avoid rain and snow; Keep out of long time sun exposure; Do not contact with corrosive gas and mechanical damage; Strictly stacking limitation applied (up to two layers). The transportation of PC and power distribution cabinet should be stable, handle with care. Do not put it upside down, keep out of rain and moisture, avoid mechanical damage as well.

##### **2. Storage**

The storage temperature of the display module is  $-20$  °C --  $40$  °C, and the relative humidity is: 10% --70% RH, without condensation. No acid-base and corrosive gas at the storage place, No strong mechanical vibration and do not close to magnetic field. Free of fire and explosion hazards. The storage time shall not exceed 3 months.

# 10

## Other Information

	Specification	HAI0136
Physical Parameter	Pixel Pitch	1.5625 mm
	Pixel Configuration	3 in one SMD
	Screen Resolution (W×H)	1,920×1,080
	Screen Dimensions (W×H×D) (mm)	3004×1774.5×32.3mm(w/o Screen Frame)
	No. of Cabinet Per Screen (W×H)	5×5
	No. of Modules Per Cabinet (W×H)	4×1
	Panel Dimensions (W×H×D) (mm)	600×337.5×32.3mm
	Screen Weight	110Kg(w/o Screen Frame)
	Aspect Ratio	16:9
Optical Parameter	Brightness	100-600Nit Adjustable
	Contrast Ratio	3,000: 1
	Viewing Angle(H/V)	150°/140°
	Processing	16 bits
	Color Temperature - Default	9300K
	Color Temperature - Adjustable	2,000~ 9.300K
Electrical Parameter	Input Voltage	AC 100-240V~ 50/60Hz
	Max. Power Consumption(W/Screen)	1800
	Refresh Rate	3,840Hz
Operation Conditions	Operating Temp/Humidity	0 - 40 °C/ 10% - 90%RH (no frost)
	Storage Temp/Humidity	-20 - 40 °C/ 10% - 65%RH (no frost)
	IP Rating	IP50
	Expected LED Lifetime (Max)	100,000 Hrs
Connectivity	WIFI	2.4G&5G
	Bluetooth	BT5.0
	Input	HDMI 2.0×2
	USB	USB 2.0×3
	Audio Output	SPDIF×1
	Earphone	Yes
	SERVICE Port	Yes



System	OS	Android 9.0
	CPU	2 core A72+2 core A53
	DDR	3GB
	ROM	64GB
	Language	(Chinese/English(Default)/ French, German, Spanish, Italian, Polish, Arabic
Speaker		Built in 60W (10W×6)
Servicing		Front
Optional Accessory		Mobile Cart/Wall bracket/OPS/Dongle
Controller		Embedded

**The supported video formats are as follows:**

Encapsulation	Video decoding				Audio decoding
	Type	Resolution(Max)	Bit rate(Max)	Frame rate(Max)	
.avi	Xvid	1920×1080	40Mbps	60fps	Dolby Audio, MPEG1(Layer1,2,3)
.avi .mpg .ts	MPEG2	1920×1080	80Mbps	60fps	Dolby Audio, MPEG1(Layer1,2,3)
.ts .mkv .avi .mp4 .flv	H.264	4096×2160	135Mbps	60fps	Dolby Audio, AAC, MPEG1(Layer1,2,3)
.avi .mkv .mov	MPEG4	1920×1080	40Mbps	60fps	Dolby Audio, MPEG1(Layer1,2,3)
.ts .mkv .mp4	H.265	4096×2160	100Mbps	60fps	Dolby Audio, AAC, MPEG1(Layer1,2,3)

Dolby Audio: Support Dolby Digital、Dolby Digital Plus、Dolby AC4.

**NOTE**

Formats listed above may not all supported by the device as video making tools are not unified.

Signal formats supported by HDMI port	
RGB/60Hz	640 × 480, 800 × 600, 1024 × 768
YUV/50Hz	576i, 576p, 720p, 1080i, 1080p
YUV/60Hz	480i, 480p, 720p, 1080i, 1080p
YUV/24Hz 25Hz 30Hz	3840×2160, 4096× 2160
YUV420/50Hz 60Hz	3840×2160, 4096× 2160
YUV444/50Hz 60Hz	3840×2160, 4096× 2160
RGB444/50Hz 60Hz	3840×2160, 4096×2160

# 11 Installation Guideline

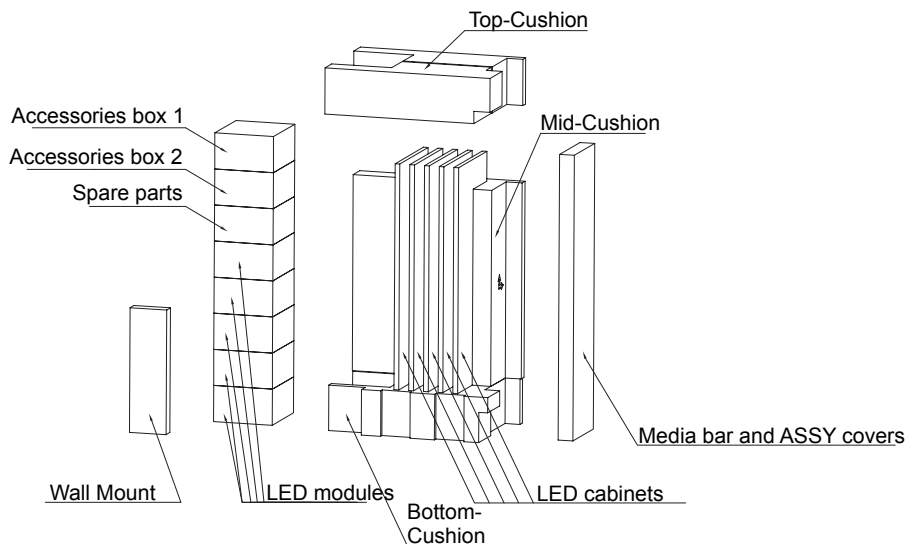

## Unpacking Inspection

LED cabinets: 5 columns

Media bar and ASSY covers: 1 box

Wall mount: 1 box

LED modules: 5 boxes

Spare parts: 1 box

Accessories box 1

Accessories box 2

## Accessories Box

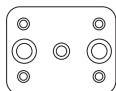

Connecting block



M6 stepped screw



Connecting screw M6x16



M8 wall-mount screw



SJ2836-87 M4x8

## Wall Mount

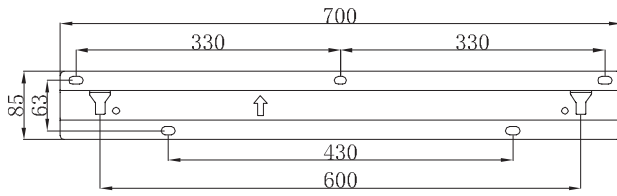

Wall bracket



Screw ST8x55C



Expansion pipe



M6x25

## Wall Mount Installation

Fix the 4pcs of crossbeam to the wall according to the positions and dimensions of the wall mount and the assembled product shown in the figure below (uses 5pcs of ST8×55C screw and 5pcs of expansion tube for each crossbeam). Pay attention that when punching holes in the wall, the position and size of holes should be calculated and measured according to the position and dimension diagram of the assembled product and the wall mount;

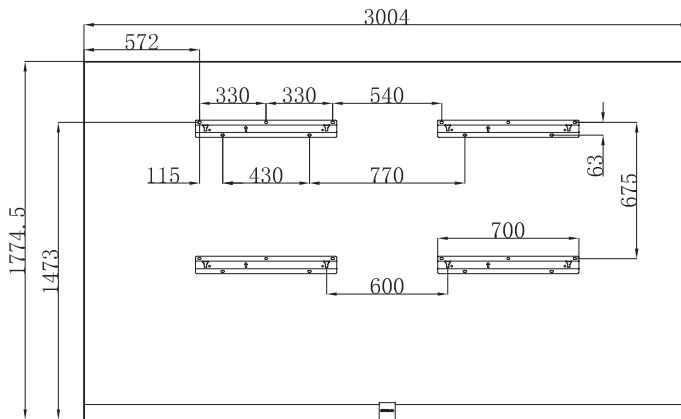

## Mobile Cart Assembly (Optional)

1 Unpack the mobile cart; check if the mobile cart parts are complete (3pcs of crossbeam, 2pcs of pillar (left and right)):

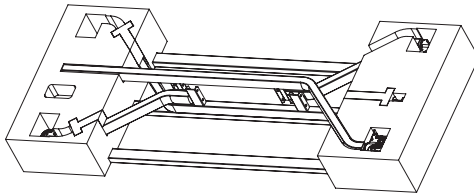

- As shown in the figure below, lay a piece of cloth on the workbench (the minimum size is 1500mm (length) \* 1000mm (width) \* 410mm (height)) to prevent scratch. You can also use the packaging box as a workbench.
- Place the 3pcs of crossbeam on the workbench in the arrow direction shown in the figure, with a spacing about 615mm between each other (pay attention to the difference in the appearance of the upper two crossbeams and the lower crossbeam).

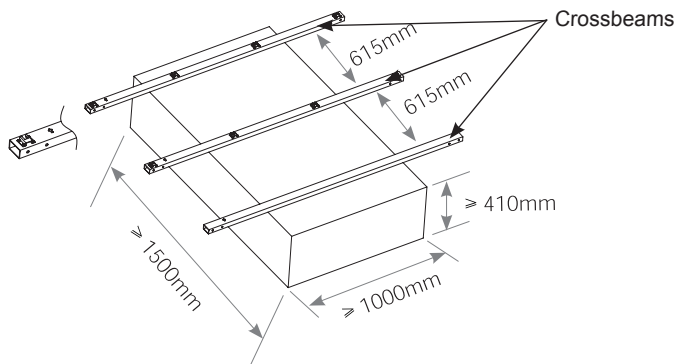

4 Find the top side of the mobile cart. Following the direction shown in the figure, insert the mounting tenons on the left and right pillars into the crossbeams, and then fix the 22pcs of M8×25 set screws and gaskets connecting these five components (do not tighten them too much for the time being).

Tips: Ask someone to help you, so that the left and right pillars can be installed simultaneously in order to keep balance. Do not reverse the front side and rear side during installation;

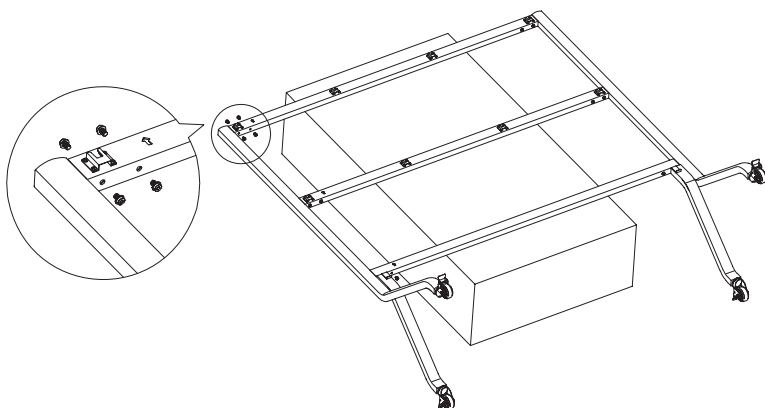

5 Let the mobile cart stand upright; fix the 22pcs of set screws if there is no abnormality.

6 The assembled mobile cart is shown below:

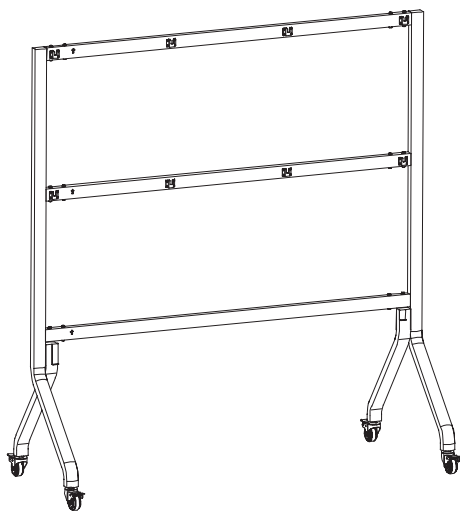

## Packing List of Media Bar and ASSY Covers

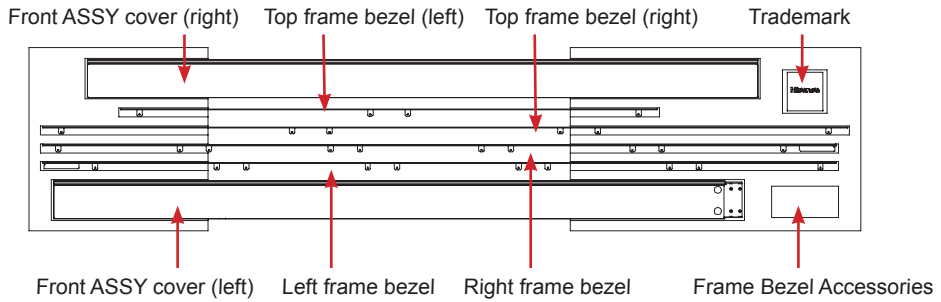

## Frame Bezel Accessories



GB/T 819.1-2000 M4×8



GB/T 819.1-2000 M3×6



M6×12



SJ2836-87 M3×8

## Frame Bezels Installation

- 1 Take the front ASSY covers (left and right) out of the front bezels packaging box; remove the 6pcs of M3×6 screws (3pcs on the left side and 3pcs on the right side), and keep the removed screws properly. Then, remove the top covers of the front ASSY covers respectively (left and right), and put them aside to avoid damage and scratch;



Respectively remove the 6pcs of screws in the front ASSY covers (left and right)  
at the positions shown in the figure

## 2 OPS (Optional) and Frame Bezels Assembly

1) Take the OPS packaging box out of the accessories box 1. Fix the 4pcs of M3 stepped screw included in the packaging box to the front ASSY cover (right) at the positions shown in the figure;

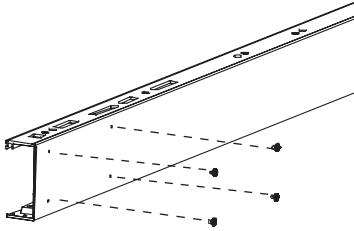

2) Take out the OPS, insert it into the bracket and then tighten the 2pcs of thumb screws. Put the module aside to avoid dropping or scratch;

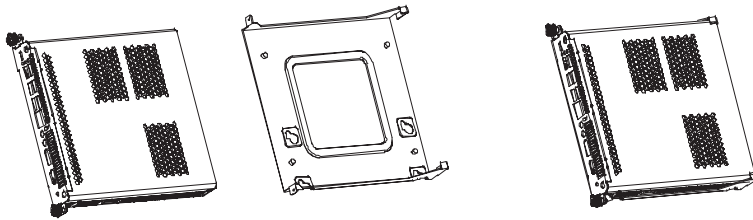

3) After assembly of the whole product, connect the assembled OPS module to the corresponding position of the front ASSY cover (right);

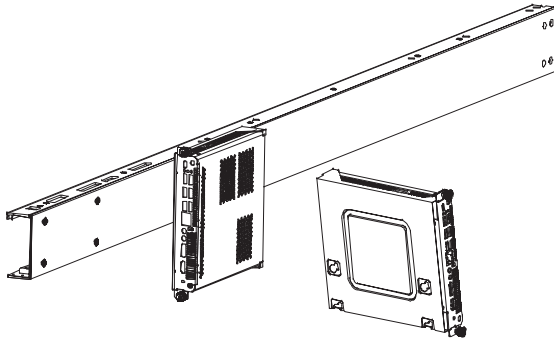

3 Assemble the left and right rear covers of the front ASSY cover: connect the left and right rear covers together according to the positions shown in the figure, and use 8pcs of GB/T 819.1-2000 M4×8 screws to fix the covers. Put the assembled front ASSY cover (rear) aside to avoid dropping or scratch;

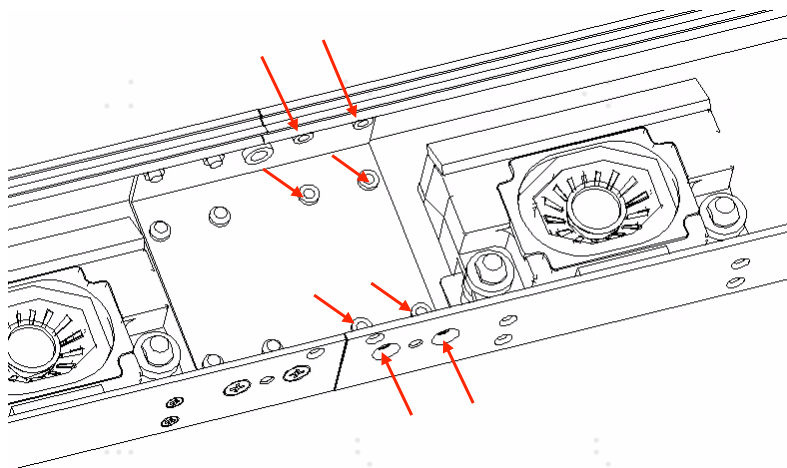

## LED Cabinets Installation (5×5)

1 Take out the Column 3 LED cabinets. As shown in the figure below, use 16pcs of connecting screws (M6×16) to fix the 8 connecting blocks to the LED cabinets; then fix 4pcs of M8 wall-mount screws respectively to the 4 connecting blocks at the positions shown in the figure.

	Column 1	Column 2	Column 3	Column 4	Column 5
Row E	E1	E2	E3	E4	E5
Row D	D1	D2	D3	D4	D5
Row C	C1	C2	C3	C4	C5
Row B	B1	B2	B3	B4	B5
Row A	A1	A2	A3	A4	A5

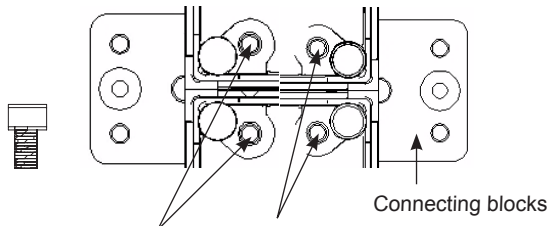
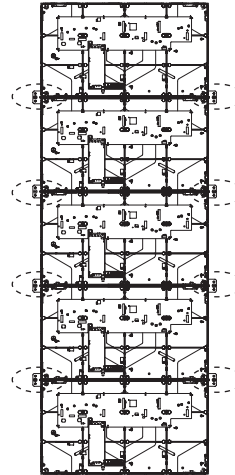

Use 4pcs of M6×16 connecting screws for fixation between every two LED cabinets

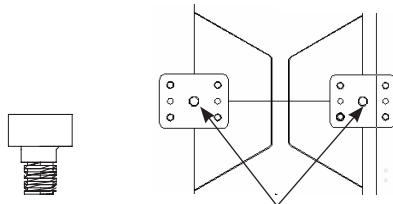

Fix 4pcs of M8 wall-mount screws respectively at the positions shown in the figure.

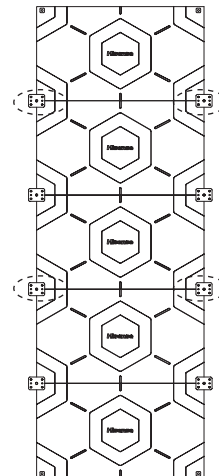

2 Hang the Column 3 LED cabinets assembled with connecting blocks and wall-mount screws to the fixed wall bracket (or mobile cart) at the hanging position shown in the figure. Fix 4pcs of M6×25 screws at the positions shown in the figure.

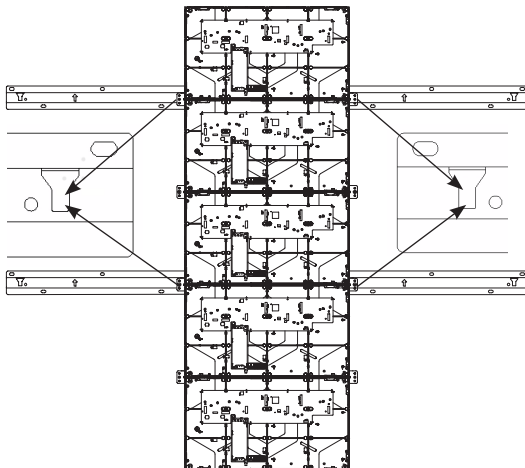

Place 4pcs of M8 wall-mount screws respectively at the positions corresponding to the 4pcs of wall bracket

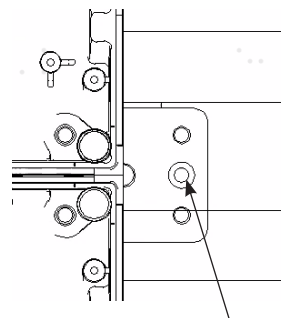

When using the wall mount, 4pcs of M6×25 screw should be fixed at the 4 connecting blocks shown in the figure



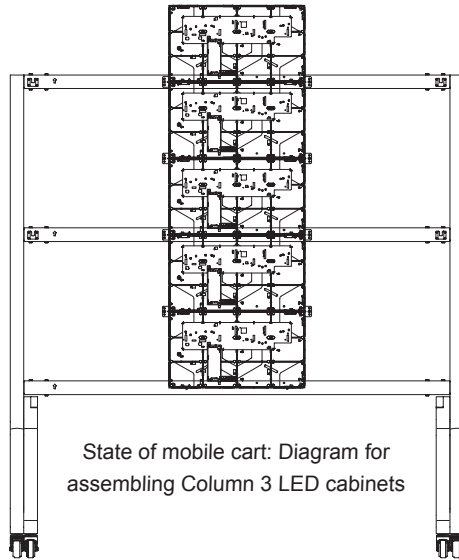

3 Hang the assembled front ASSY cover (rear) to the Column 3 LED cabinets. Use 3pcs of M6×12 screws included in the frame bezel accessories to fix LED cabinet at the bottom in Column 3 with the front ASSY cover (rear).

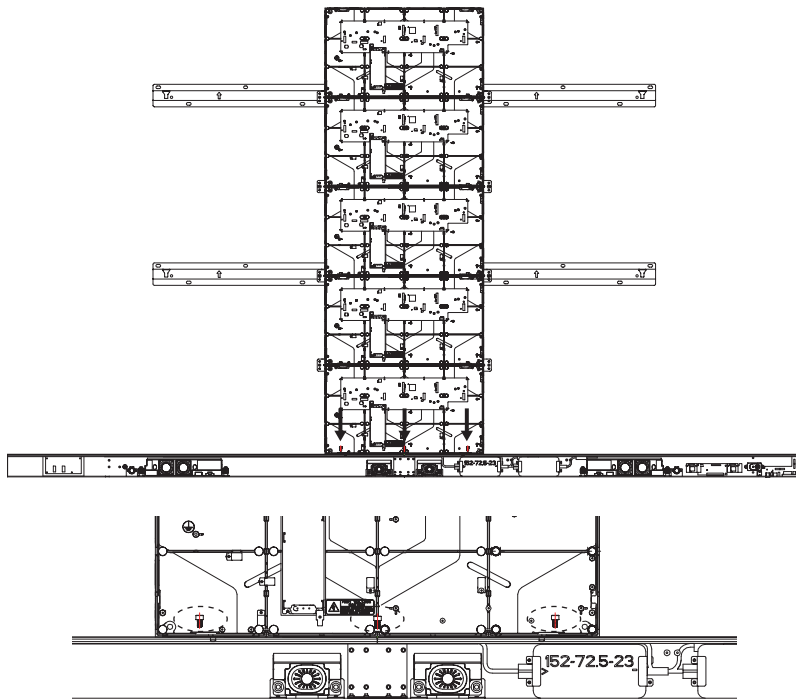

4 Take out the Column 2 LED cabinets. Use 8pcs of connecting screws (M6×16) to fix the 4 connecting blocks to the left side of LED cabinets, then fix 2pcs of M8 wall-mount screws to the 2 connecting blocks respectively at the positions shown in the figure.

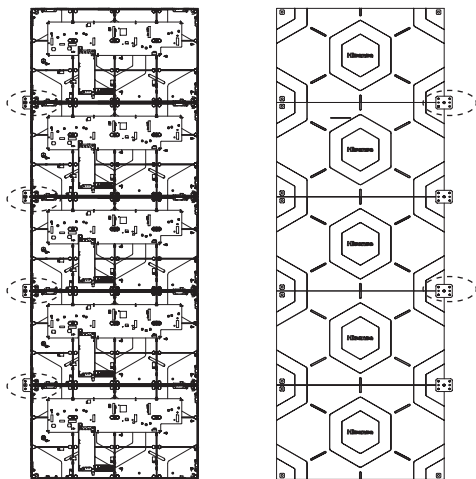

Connecting blocks

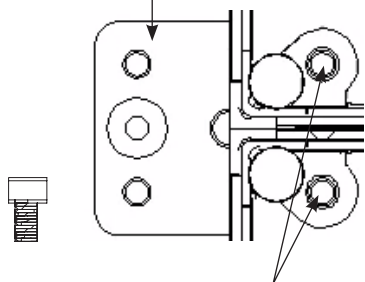

Use 2pcs of M6×16 connecting screws for fixation between every two LED cabinets

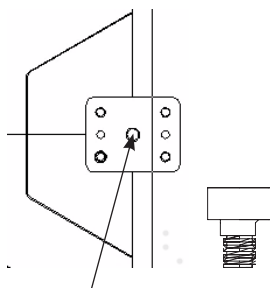

Fix 2pcs of M8 wall-mount screws at the positions shown in the figure respectively.

5 Hang the Column 2 LED cabinets assembled with connecting blocks and wall-mount screws to the left side of Column 3 LED cabinets: first, use 10pcs of M6 stepped screws to fix the Column 3 LED cabinets with the Column 2 LED cabinets (properly arrange the gap between the Column 2 and 3 LED cabinets); then use 8pcs of cabinet connecting screws (M6×16) to fix the right side of Column 2 LED cabinets to the connecting blocks on the left side of Column 3 LED cabinets; at last, use 3pcs of M6×12 screws included in the frame bezel accessories to fix the LED cabinets at the bottom with the media bar and ASSY covers.

The steps for hanging on the mobile cart are identical to those for hanging on the wall mount;

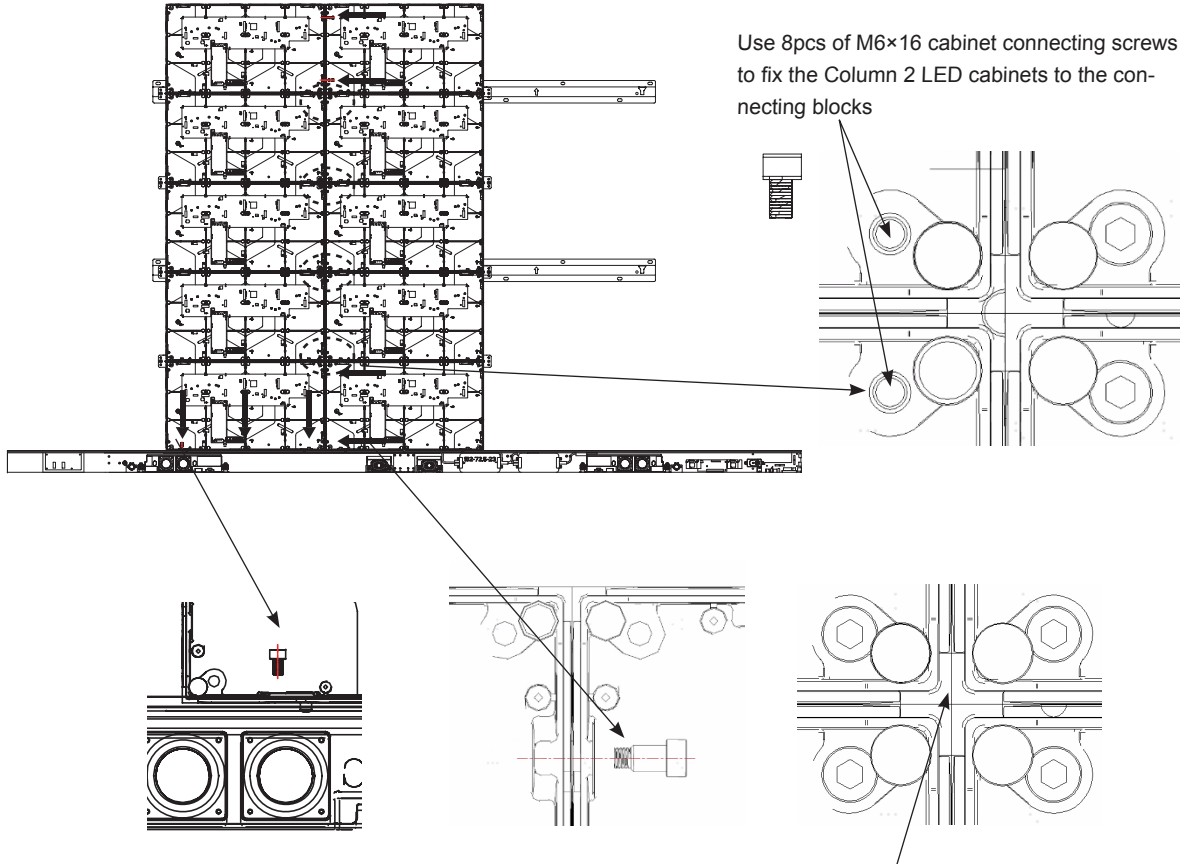

Use 8pcs of M6×16 cabinet connecting screws to fix the Column 2 LED cabinets to the connecting blocks

Finally, use 3pcs of M6×12 screws to fix the bottom LED cabinet in Column 2 to the front ASSY cover (rear).

First, use 10pcs of M6 stepped screws to fix the Column 2 LED cabinets together with the Column 3 LED cabinets. Note: In this process, properly arrange the gap between the Column 2 and Column 3 LED cabinets;

6 Refer to Steps 3 and 4 to complete the assembly of Column 4 LED cabinets; also properly arrange the gap between the cabinets ;

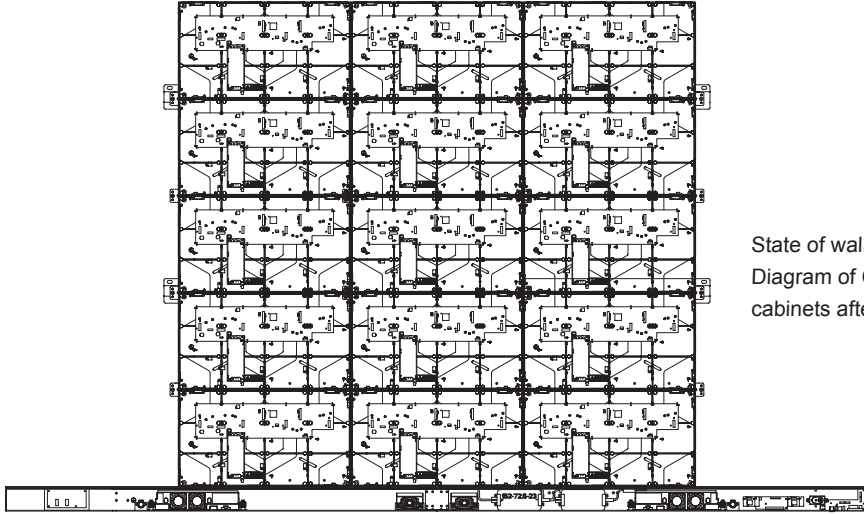

State of wall mount:  
Diagram of Column 2, 3 and 4 LED  
cabinets after assembly

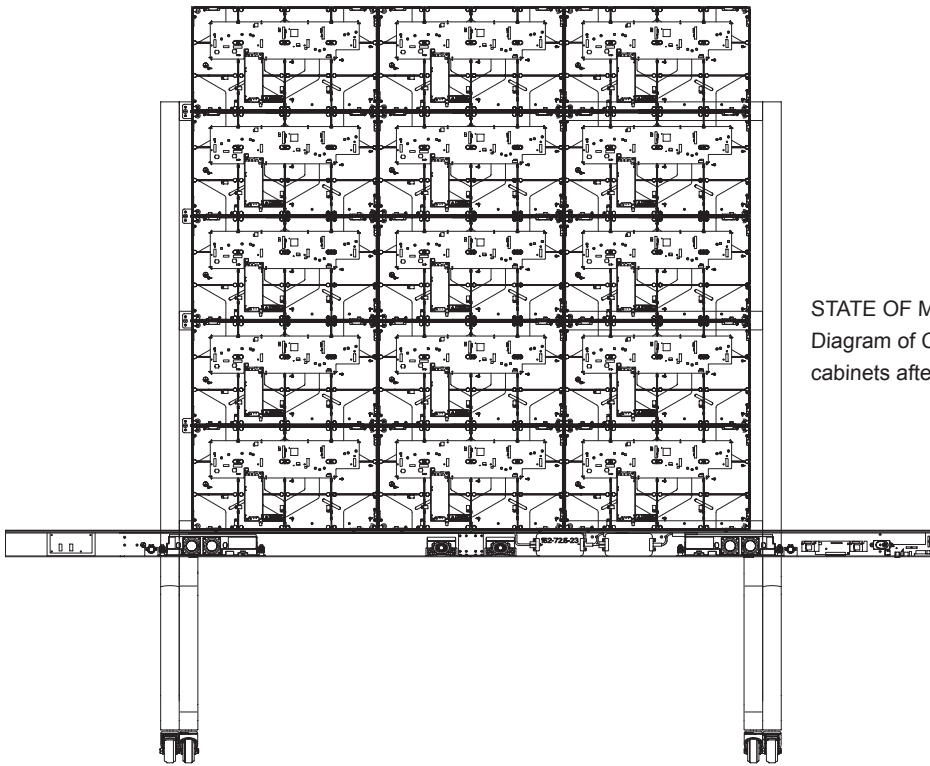

STATE OF MOBILE CART:  
Diagram of Column 2, 3 and 4 LED  
cabinets after assembly

7 Take out the Column 1 LED cabinets, and place them to the left of Column 2 LED cabinets. Use 10pcs of M6 stepped screws to fix the Column 2 LED cabinets with the Column 1 LED cabinets (Note: In this process, properly arrange the gap between the Column 1 and Column 2 LED cabinets). Use 8pcs of cabinet connecting screws (M6×16) to fix the Column 1 LED cabinets to the connecting blocks on the left side of Column 2 LED cabinets. At last, use 3pcs of M6×12 screws included in the frame bezel accessories to fix the cabinets at the bottom with the media bar and ASSY covers.

The steps for hanging on the mobile cart are identical to those for hanging on the wall mount;

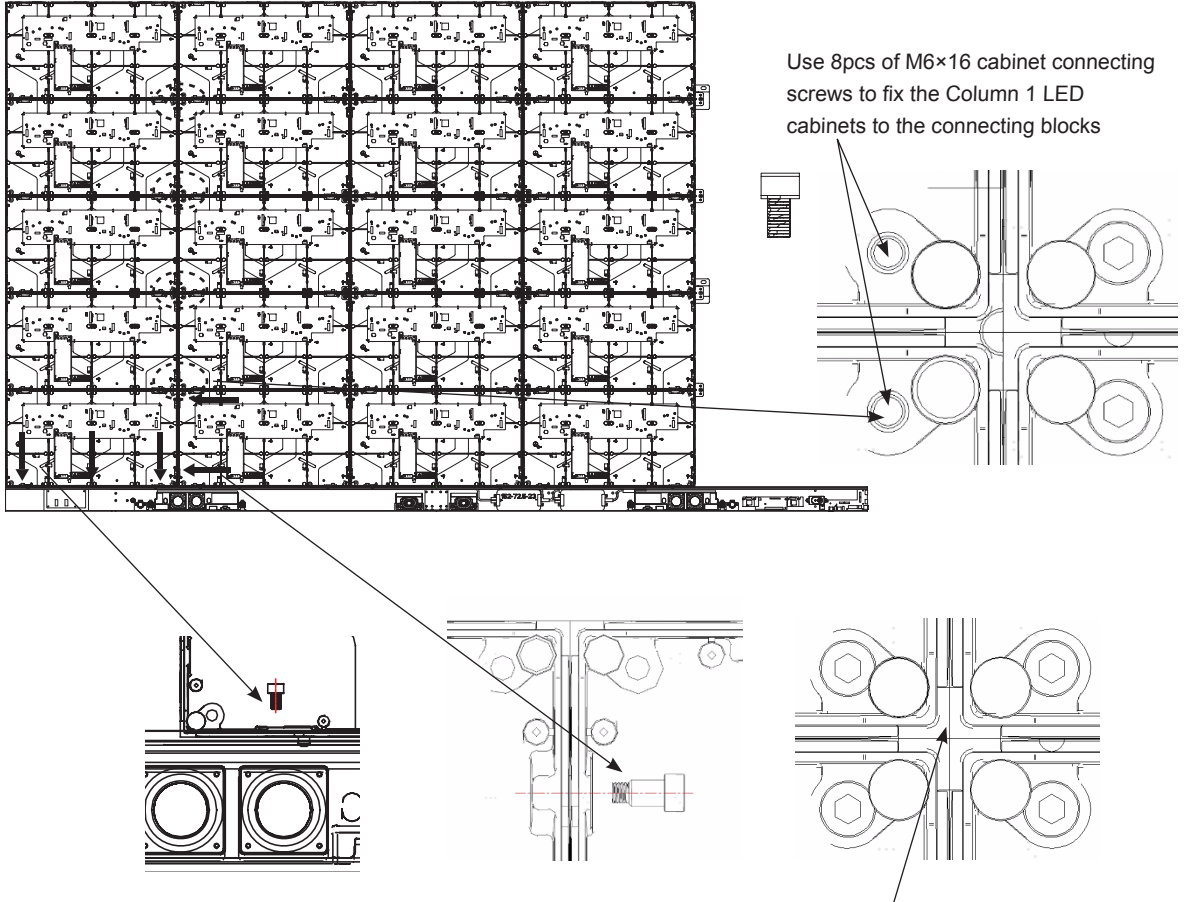

At last, use 3pcs of M6×12 screws to fix the bottom LED cabinet in Column 1 to the front ASSY cover (rear).

First, use 10pcs of M6 stepped screws to fix the Column 2 LED cabinets together with the Column 1 LED cabinets. Note: In this process, properly arrange the gap between the Column 1 and Column 2 LED cabinets;

8 Refer to Step 7 to complete the assembly of Column 5 LED cabinets; also properly arrange the gap between the columns;

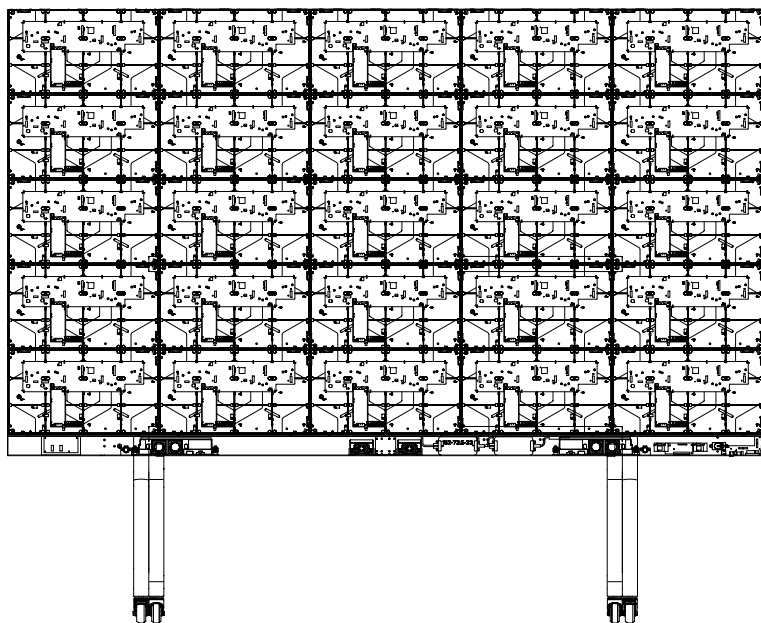
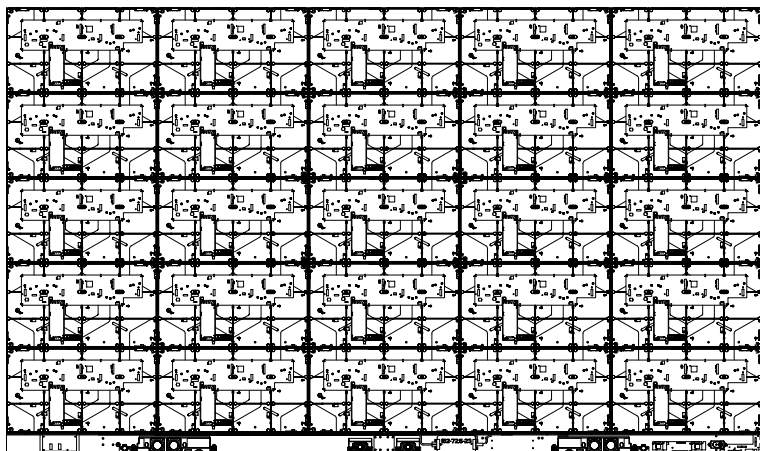

9 Attach the top frame bezel, left frame bezel and right frame bezel onto the connected LED cabinets in sequence, and use M3×8 screws to fix them to the LED cabinets.

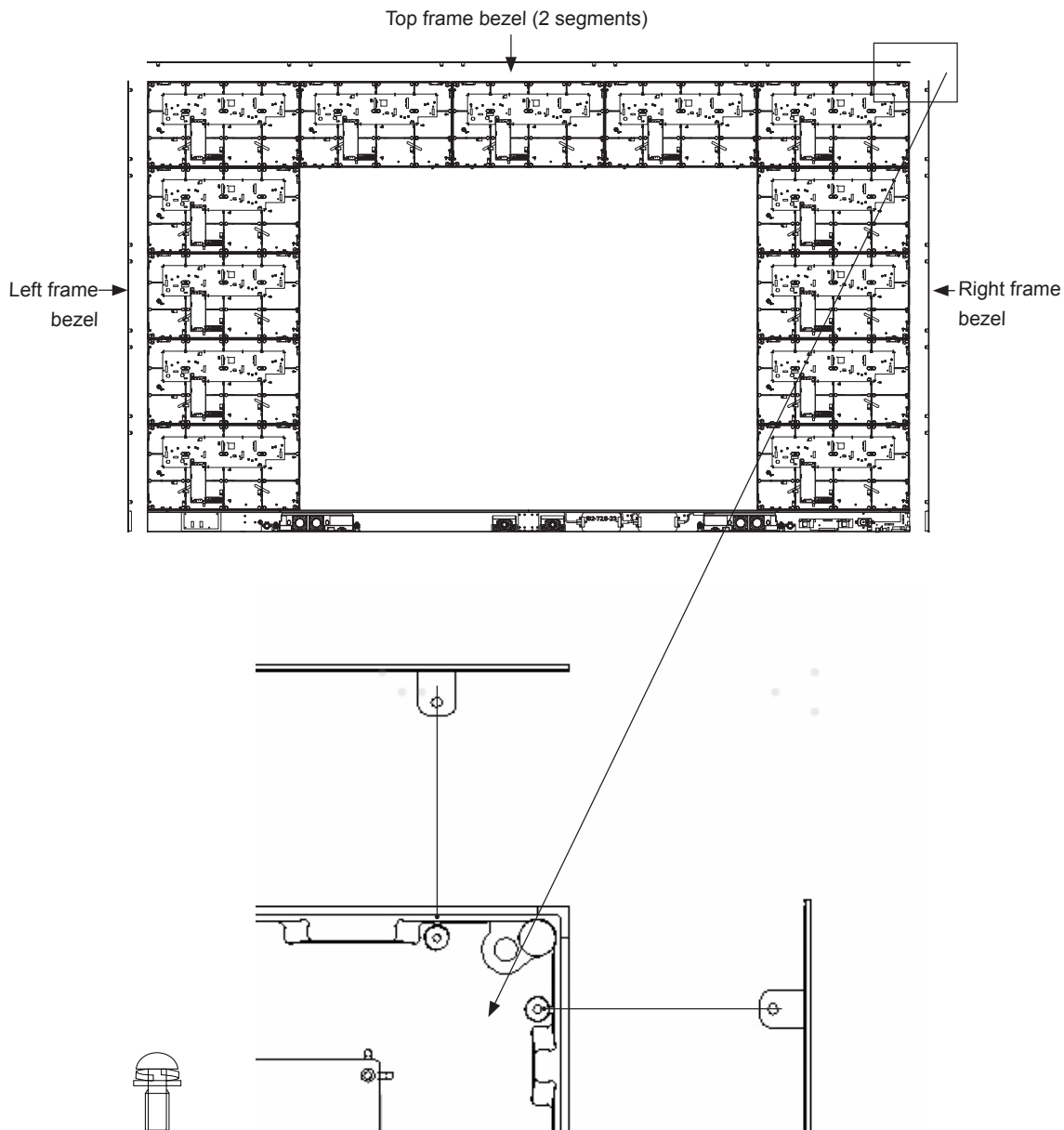



## Connection

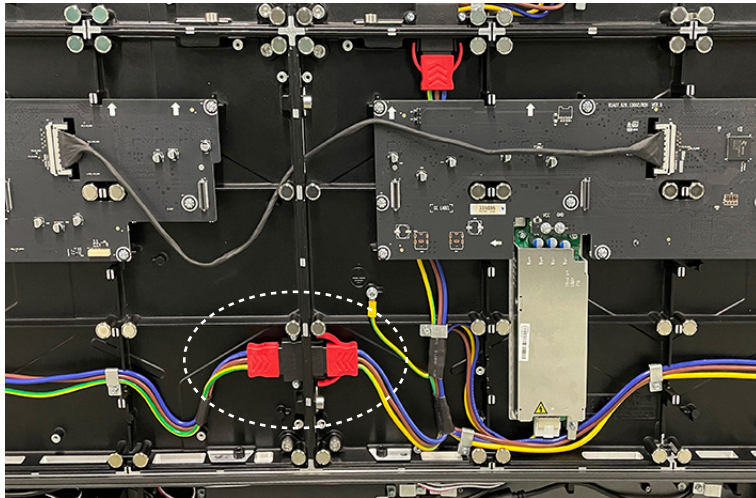

power connection between A1~A2, A2~A3, A3~A4, A4~A5



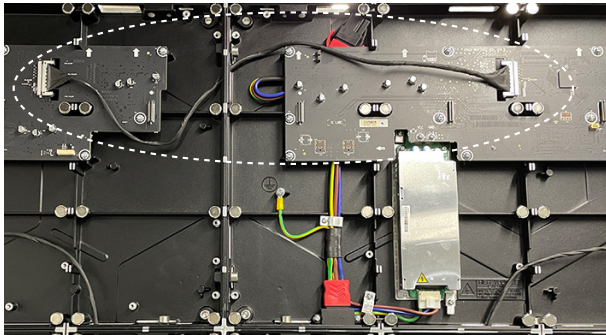
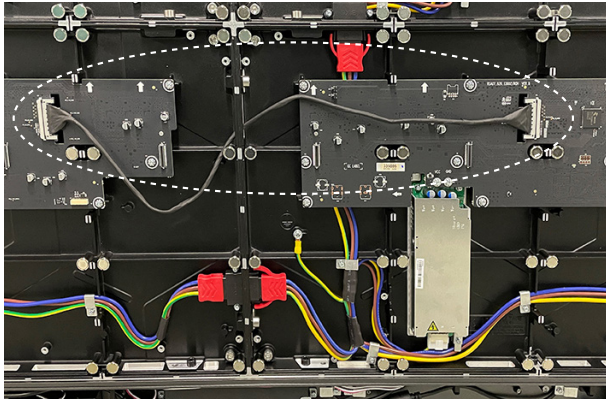

cable connection A1~A2, A3~A4, E2~E3, E4~E5

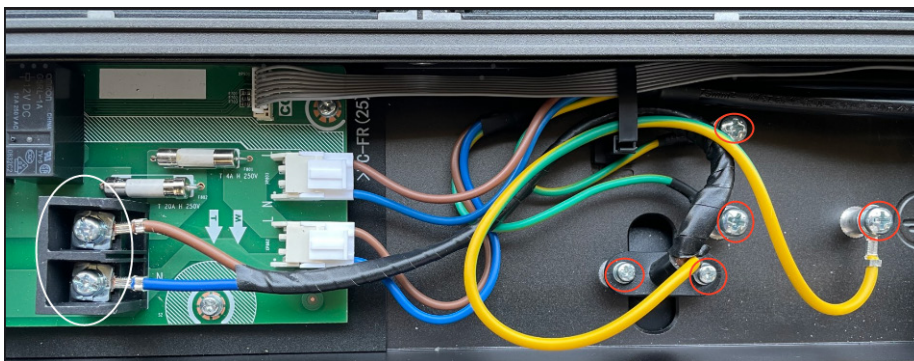
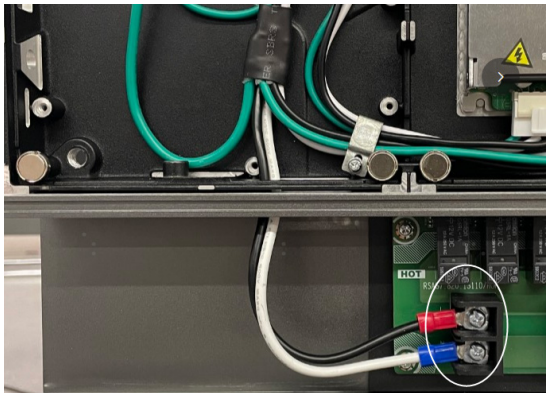

power connection between A1 box and bottom front cover

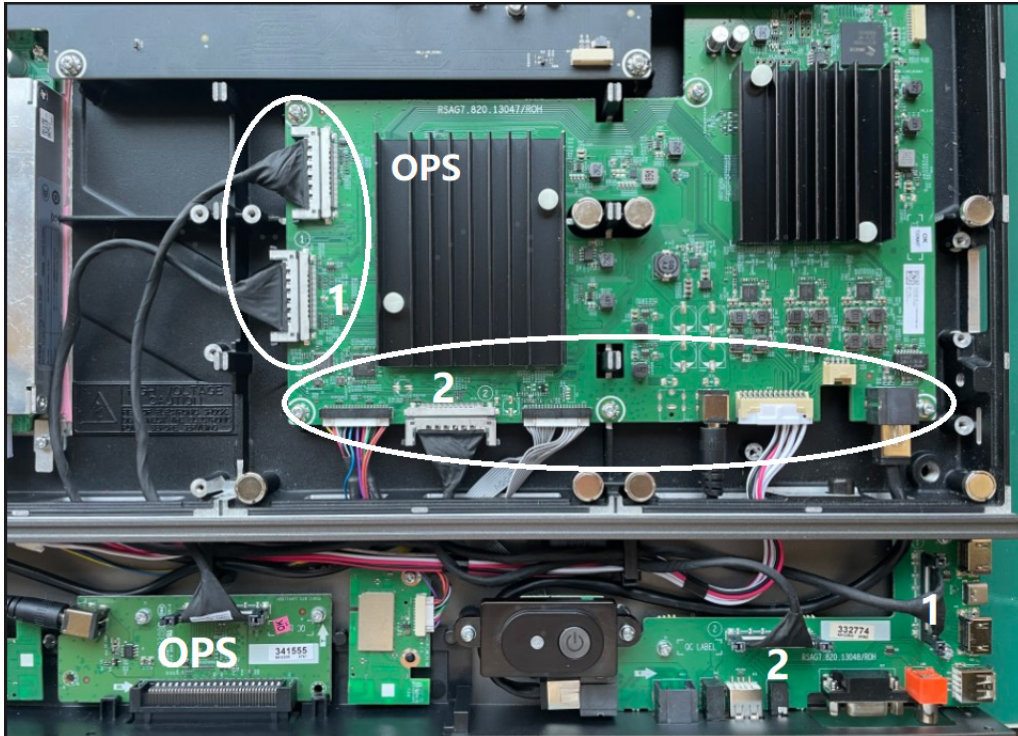

power connection between A5 box and bottom front cover

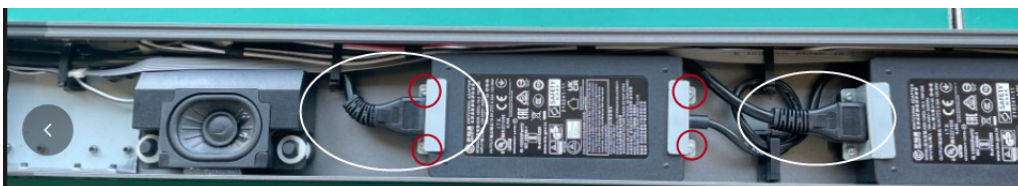
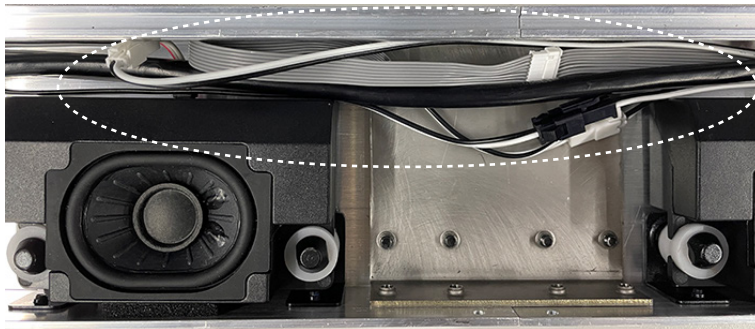

at the center of the front cover  
 remove four screws, put the wires into the space between the adapter and the front shell, and then fix the adapter with four screws.

## LED Modules Installation

Start installation of the LED modules from Row A, and then install Row B, C, D and E in sequence. Install the Row A LED modules from A1-1 to A5-4. After completing the installation of Row A, check the evenness and gap of the LED modules; and then install the LED modules in Row B, C, D and E in sequence.

	Column 1				Column 2				Column 3				Column 4				Column 5			
Row E	E1-1	E1-2	E1-3	E1-4	E2-1	E2-2	E2-3	E2-4	E3-1	E3-2	E3-3	E3-4	E4-1	E4-2	E4-3	E4-4	E5-1	E5-2	E5-3	E5-4
Row D	D1-1	D1-2	D1-3	D1-4	D2-1	D2-2	D2-3	D2-4	D3-1	D3-2	D3-3	D3-4	D4-1	D4-2	D4-3	D4-4	D5-1	D5-2	D5-3	D5-4
Row C	C1-1	C1-2	C1-3	C1-4	C2-1	C2-2	C2-3	C2-4	C3-1	C3-2	C3-3	C3-4	C4-1	C4-2	C4-3	C4-4	C5-1	C5-2	C5-3	C5-4
Row B	B1-1	B1-2	B1-3	B1-4	B2-1	B2-2	B2-3	B2-4	B3-1	B3-2	B3-3	B3-4	B4-1	B4-2	B4-3	B4-4	B5-1	B5-2	B5-3	B5-4
Row A	A1-1	A1-2	A1-3	A1-4	A2-1	A2-2	A2-3	A2-4	A3-1	A3-2	A3-3	A3-4	A4-1	A4-2	A4-3	A4-4	A5-1	A5-2	A5-3	A5-4

After completing the installation of LED modules, install the panel of the front ASSY cover to the rear cover of the front ASSY cover. Use 14pcs of M3×6 screws to fix the front and rear covers of the front ASSY cover. Attach the trademark to the front ASSY cover (Note: Place the 2 locating studs of the trademark into the locating holes in the front ASSY cover);

